

KALLBODA

en



Design and Quality
IKEA of Sweden

Table of contents

Safety	4	Information on detergents	21
General information	4	Adding detergent	21
Intended use	4		
Restriction on user group.....	4	Tableware	22
Safe installation.....	4	Damage to glass and tableware.....	22
Safe use	5	Arrange tableware	22
Damaged appliance.....	6	Removing tableware	23
Risk to children.....	6		
Preventing material damage	8	Basic operation	23
Safe installation.....	8	Switching on the appliance.....	23
Safe use	8	Setting a programme.....	23
		Setting additional functions.....	23
		Setting timer programming.....	23
		Starting the programme	23
		Interrupting programme.....	23
		Terminate programme.....	23
		Switching off appliance	23
Environmental protection and saving energy	8		
Disposing of packaging.....	8	Basic settings	24
Saving energy	8	Overview of basic settings	24
Drying.....	8	Changing basic settings	25
Aqua sensor	9		
Sensors.....	9	Cleaning and servicing	25
		Cleaning the tub	25
Installation and connection	9	Cleaning products.....	25
Scope of supply	9	Tips on appliance care.....	25
Installing and connecting the appliance	9	Machine Care 	25
Drainage connection.....	9	Filter system	26
Drinking water connection	9	Cleaning spray arms	27
Electrical connection	10		
		Troubleshooting	28
Product description	11	Error code / Fault display / Signal.....	28
Appliance	11	Washing results	29
Control panel	12	Information on display panel	33
		Malfunctions	33
Overview of programmes	14	Mechanical damage.....	34
Information for test institutes.....	15	Noise	34
		Clean wastewater pump.....	36
Additional functions	15		
Features	15	Transportation, storage and disposal	36
Top basket	15	Removing the appliance.....	36
Bottom basket.....	16	Protect appliance from frost.....	36
Cutlery drawer	16	Transporting the appliance	36
Etagere	17	Disposing of old appliance	37
Folding prongs	17		
Basket heights.....	18	Technical specifications	37
		Information regarding free and open source software..	37
Before first use	18	Declaration of Conformity	37
Performing the initial configuration.....	18	IKEA guarantee	38
		After-sales service	39
Water softening system	18		
Overview of water hardness settings	18		
Setting the water softening system.....	18		
Special salt	19		
Switching off the water softening system.....	19		
Regeneration of the water softening system	19		
Rinse aid system	19		
Rinse aid	19		
Setting the amount of rinse aid	20		
Switching the rinse aid system off	20		
Detergent	20		
Suitable detergents	20		
Unsuitable detergents	21		

Safety

Observe the following safety instructions.

General information

- Read this instruction manual carefully.
- Keep the instruction manual and the product information safe for future reference or for the next owner.
- Do not connect the appliance if it has been damaged in transit.

Intended use

Only use this appliance:

- For cleaning household tableware.
- in private households and in enclosed spaces in a domestic environment.
- Up to an altitude of 2500 m above sea level.

Restriction on user group

This appliance may be used by children aged 8 or over and by people who have reduced physical, sensory or mental abilities or inadequate experience and/or knowledge, provided that they are supervised or have been instructed on how to use the appliance safely and have understood the resulting dangers.

Do not let children play with the appliance.

Cleaning and user maintenance must not be performed by children unless they are being supervised.

Keep children under the age of 8 years away from the appliance and power cable.

Safe installation

WARNING – Risk of injury!

- Improper installation may cause injury.
 - When installing and connecting the appliance, follow the instructions in the manual and installation instructions.

WARNING – Risk of electric shock!

- Incorrect installation is dangerous.
 - Connect and operate the appliance only in accordance with the specifications on the rating plate.
 - Always use the supplied power cable for the new appliance.
 - Connect the appliance to a power supply with alternating current only via a properly installed socket with earthing.
 - The protective conductor system of the domestic electrical installation must be properly installed.
 - Never equip the appliance with an external switching device, e.g. a timer or remote control.
 - When the appliance is installed, the mains plug of the power cord must be freely accessible. If free access is not possible, an isolating switch must be integrated into the permanent electrical installation according to the installation regulations.
 - When installing the appliance, check that the power cable is not trapped or damaged.

- Cutting through the supply hose or immersing the Aqua-Stop valve in water is dangerous.
 - Never immerse the plastic housing in water. The plastic housing on the supply hose contains an electric valve.
 - Never cut through the supply hose. The supply hose contains electric power cables.

⚠ WARNING – Risk of fire!

- It is dangerous to use an extended power cord and non-approved adapters.
 - Do not use extension cables or multiple socket strips.
 - Only use adapters and power cords approved by the manufacturer.
 - If the power cord is too short and a longer one is not available, please contact an electrician to have the domestic installation adapted.
- Contact between the appliance and installation lines may lead to a defect in these lines, e.g. gas pipes and power lines. Gas from a corroded gas pipe can ignite. A damaged power line can cause a short circuit.
 - Check that there is a distance of at least 5 cm between the appliance and installation lines.

⚠ WARNING – Risk of injury!

- Hinges move when opening and closing the appliance door and can cause injury.
 - If built-under or integrable appliances are not in a cavity so that one side is accessible, the hinge area must be covered at the side. Covers are available from IKEA or Customer Service.

⚠ WARNING – Risk of tipping!

- Improper installation may cause the appliance to tip up.
 - Only install built-under or integrable appliances under a continuous worktop that is securely connected to adjacent cabinets.

Safe use

⚠ WARNING – Risk of serious harm to health!

- Failure to comply with safety instructions and directions for use on packagings of detergent and rinse aid products may cause serious harm to health.
 - Follow the safety instructions and directions for use on the packagings of detergent and rinse aid products.

⚠ WARNING – Risk of explosion!

- Adding solvents to the interior of the appliance may cause explosions.
 - Never add solvents to the interior of the appliance.
- Highly caustic alkaline or highly acidic cleaning agents in conjunction with aluminium parts in the interior of the appliance may cause explosions.
 - Never use highly caustic alkaline or highly acidic cleaning agents, in particular commercial or industrial products, in conjunction with aluminium parts (e.g. grease filters of extractor hoods or aluminium pans), e.g. for the Machine Care programme.

⚠ WARNING – Risk of injury!

- Leaving the appliance door open may result in injury.
 - Only open the appliance door to load or unload tableware in order to prevent accidents, e.g. through tripping.
 - Do not sit or stand on the appliance door when open.

- Knives and utensils with sharp points can cause injuries.
 - Arrange knives and utensils with sharp points in the cutlery basket with the points downwards, on the knife shelf or in the cutlery drawer.

⚠ WARNING – Risk of scalding!

- If you open the appliance door while the programme is running, hot water may splash out of the appliance.
 - Open the appliance door carefully if the programme is still running.

⚠ WARNING – Risk of electric shock!

- An ingress of moisture can cause an electric shock.
 - Only use the appliance in enclosed spaces.
 - Never expose the appliance to intense heat or humidity.
 - Do not use steam- or high-pressure cleaners to clean the appliance.
- If the insulation of the power cord is damaged, this is dangerous.
 - Never let the power cord come into contact with hot appliance parts or heat sources.
 - Never let the power cord come into contact with sharp points or edges.
 - Never kink, crush or modify the power cord.

⚠ WARNING – Risk of burns!

- The blow opening becomes hot and can cause burns.
 - Never touch the blow opening.

Damaged appliance

⚠ WARNING – Risk of electric shock!

- If the appliance or the power cord is damaged, this is dangerous.
 - Never operate a damaged appliance.
 - Never operate an appliance with a cracked or fractured surface.
 - Never pull on the power cord to unplug the appliance. Always unplug the appliance at the mains.
 - If the appliance or the power cord is damaged, immediately unplug the power cord or switch off the fuse in the fuse box and turn off the water tap.
 - Call customer services.
- Incorrect repairs are dangerous.
 - Repairs to the appliance should only be carried out by trained specialist staff.
 - Only use genuine spare parts when repairing the appliance.
 - If the power cord or the appliance power cable of this appliance is damaged, it must be replaced with a special power cord or special appliance power cable, which is available from the manufacturer or its Customer Service.

Risk to children

⚠ WARNING – Risk of suffocation!

- Children may put packaging material over their heads or wrap themselves up in it and suffocate.
 - Keep packaging material away from children.
 - Do not let children play with packaging material.
- Children may breathe in or swallow small parts, causing them to suffocate.
 - Keep small parts away from children.
 - Do not let children play with small parts.
- Children may become trapped in the appliance and suffocate.
 - Use the childproof lock if fitted.

- Never let children play with or operate the appliance.

⚠ WARNING – Risk of harm to health!

- Children can lock themselves in the appliance, thereby putting their lives at risk.
 - With redundant appliances, unplug the power cord. Then cut through the cord and damage the lock on the appliance door beyond repair so that the appliance door will no longer close.

⚠ WARNING – Risk of crushing!

- With higher-level appliances, children can become crushed between the appliance door and cabinet doors underneath.
 - Keep an eye on children when opening and closing the appliance door.

⚠ WARNING – Risk of chemical burns!

- Rinse aid and detergent may cause chemical burns to the mouth, throat and eyes.
 - Keep children away from detergent and rinse aid products.
 - Keep children away from the appliance when open. The water in the interior of the dishwasher is not drinking water. It may contain residues of detergents and rinse aid.

⚠ WARNING – Risk of injury!

- Children may get their fingers caught in the slots of the tablet collecting tray and injure themselves.
 - Keep children away from the appliance when open.

Preventing material damage

Safe installation

ATTENTION!

- Improper installation of the appliance may cause damage.
 - If the dishwasher is installed above or below other domestic appliances, follow the information on installation in combination with a dishwasher in the installation instructions for the individual appliances.
 - If there is no information or if the installation instructions do not include the relevant information, contact the manufacturer of these appliances to check that the dishwasher can be installed above or below these appliances.
 - If no information is available from the manufacturer, the dishwasher should not be installed above or below such appliances.
 - To ensure the safe operation of all domestic appliances, continue following the installation instructions for the dishwasher.
 - Do not install the dishwasher under a hob.
 - Do not install the dishwasher near heat sources, e.g. radiators, heat storage tanks, ovens or other appliances that generate heat.
- Contact between the appliance and water pipes may lead to corrosion of these pipes, possibly causing them to leak.
 - Check that there is a distance of at least 5 cm between the appliance and the water pipe. The pipes supplied for the drinking water and waste water connections are not affected here.
- Modified or damaged water hoses may result in material damage and damage to the appliance.
 - Never kink, crush, modify or cut through water hoses.
 - Only use the water hoses supplied with the appliance or genuine spare hoses.

- Never re-use water hoses that have been used before.
- If the water pressure is too high or too low, the appliance may not be able to operate properly.
- Make sure that the water pressure in the water supply system is min. 50 kPa (0.5 bar) and max. 1000 kPa (10 bar).
- If the water pressure exceeds the maximum value specified, a pressure-reducing valve must be installed between the drinking water connection and the hose set of the appliance.

Safe use

ATTENTION!

- Escaping water vapour can damage fitted units.
 - When the programme ends, leave the appliance to cool down for a while before opening the door.
- Special salt for dishwashers can damage the tub due to corrosion.
 - To make sure that any special salt that escapes is washed out of the tub, add the special salt to the dispenser for special salt immediately before the programme starts.
- Detergent may damage the water softening system.
 - Only fill the dispenser of the water softening system with special dishwasher salt.
- Unsuitable cleaning agents may damage the appliance.
 - Do not use a steam cleaner.
 - So as not to scratch the finish on the appliance, do not use sponges with a rough surface or abrasive cleaning agents.
 - To prevent corrosion, do not use sponge cloths on dishwashers with a stainless steel front or rinse such cloths thoroughly several times before using them for the first time.

Environmental protection and saving energy

Disposing of packaging

The packaging materials are environmentally compatible and can be recycled.

- Sort the individual components by type and dispose of them separately.
Information about current disposal methods is available from IKEA or your local authority.

Saving energy

If you follow these instructions, your appliance will use less electricity and less water.

Use the Eco 50 ° programme.

- ✦ The Eco 50 ° programme is energy-efficient and environmentally friendly.

If you do not have much tableware to wash, use the additional Half Load function.¹

- ✦ The programme will adjust to a lower load and consumption will be reduced.
→ "Additional functions", Page 15

Change the sensor setting to the default.

- ✦ Consumption is reduced.
→ "Sensors", Page 9

Drying automatically helps to save energy.

- ✦ → "Drying", Page 8

Drying

The appliance is equipped with a container which has a mineral inside. This mineral can store moisture and heat energy and then release them again. Such drying lets you save energy.

During dishwashing heat energy is used to heat up the washing water and dry the mineral.

¹ Depending on the appliance specifications

During the drying phase moisture from the interior of the dishwasher is stored in the mineral and heat energy is released. The heat energy is blown out into the interior of the dishwasher with dry air. This speeds up and improves drying.

This drying method saves a great deal of energy.

Tip: To avoid impairing the drying performance, do not position items of tableware directly in front of the intake opening or the blow opening of the container. Do not position heat-sensitive items of tableware directly in front of the blow opening of the container.

→ "Appliance", Page 11

Aqua sensor

The aqua sensor is an optical measuring device (light barrier) which measures the turbidity of the washing water. You can save water with the aqua sensor.

Use of the aqua sensor depends on the programme. If the soiling level is high, the rinsing water is drained off and replaced with fresh water. If the soiling level is lower, the rinsing water is used in the next wash cycle, so reducing water consumption by 3-6 litres. In the automatic programmes the temperature and running time are additionally adjusted to the level of soiling.

Sensors

The sensors adjust the programme sequence and strength in the automatic programmes depending on the level and type of soiling.

The sensor has different sensitivity settings that can be changed in the basic settings.

SENSOR SETTING	DESCRIPTION
SE:00	Optimum setting for a mixed load and heavily soiled tableware. Saves both energy and water.
SE:01	Adjusts the programme strength for effective removal of food remnants even with low soiling levels. Energy and water consumption are adjusted accordingly.
SE:02	Adjusts the programme strength for difficult conditions of use, e.g. stubborn dried-on food remnants. Recommended setting when using organic or ecological detergents containing low levels of active agents. Energy and water consumption are adjusted accordingly.

Installation and connection

To ensure proper operation, connect the appliance to the power and water supply correctly. Observe the specified criteria and the installation instructions.

Scope of supply

After unpacking all parts, check for any damage in transit and completeness of the delivery.

If you have any complaints, contact IKEA or our Customer Service.

Note: The appliance has been tested at the factory to check it is in working order. It is possible that water has left marks on the appliance. These marks will disappear after the first wash cycle.

The delivery consists of the following:

- Dishwasher
- Operating instructions
- Installation Instructions
- Installation material
- Steam protection
- Salt filling aid funnel
- Mains cable

Installing and connecting the appliance

You can position your built-under or integrable appliance in a fitted kitchen between wooden and plastic walls. If you subsequently install your dishwasher as a free-standing appliance, you must stop it from tipping over, e.g. by screwing it to the wall or installing it under a continuous worktop that is securely connected to adjacent cabinets.

1. "Follow the safety instructions." → Page 4
2. "Follow the instructions for electrical connection." → Page 10
3. Check the Scope of supply and the condition of the appliance.

4. Consult the installation instructions for the installation dimensions required.
5. Make the appliance level using the height-adjustable feet. Make sure that the appliance is standing on the floor securely.
6. "Install the drainage connection." → Page 9
7. "Install the drinking water connection." → Page 9
8. Connect the appliance to the power supply.

Drainage connection

Connect your appliance to drainage connection so dirty water is discharged via the wash cycle.

Installing the drainage connection

1. Consult the installation instructions supplied for the steps required here.
2. Connect the wastewater hose to the outlet connection of the siphon using the enclosed parts.
3. When doing so, check that the wastewater hose is not kinked, crushed or twisted.
4. Also check that there is no cover in the drainage system preventing the wastewater from being discharged.

Drinking water connection

Connect your appliance to a drinking water connection.

Installing the drinking water connection

Note

- If you are replacing the appliance, you must use a new water supply hose.
1. Consult the installation instructions supplied for the steps required here.
 2. Connect the appliance to the drinking water connection using the enclosed parts.

Observe the Technical data.

3. When doing so, check that the drinking water connection is not kinked, crushed or twisted.

Electrical connection

Connecting the appliance to the electricity supply

Notes

- Please follow the "Safety instructions" → *Page 4*.
 - Connect the appliance to alternating current only, in the range of 220 - 240 V and 50 Hz or 60 Hz.
 - Please note that the water safety system is only functional if there is a power supply.
1. Insert the non-heating appliance plug of the power cable into the appliance.
 2. Insert the mains plug of the appliance into a nearby socket.
The connection data for the appliance can be found on the rating plate.
 3. Check that the mains plug is inserted properly.

Product description

Appliance

You can find an overview of the parts of your appliance here.

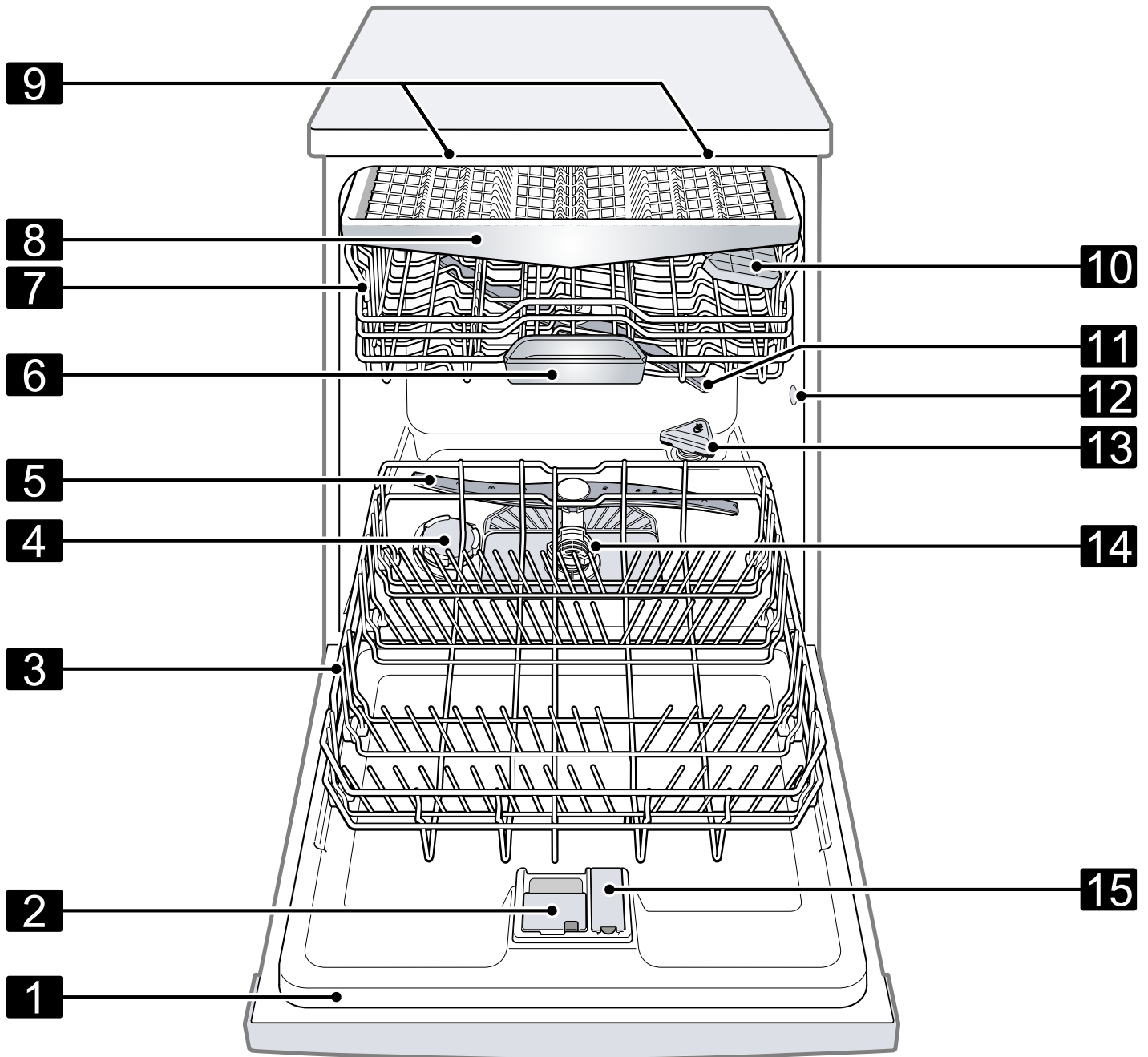

1	Rating plate	Rating plate with E number and FD number. The data you need for Customer Service.
2	Detergent dispenser	Add detergent to the detergent dispenser. → "Detergent", Page 20
3	Bottom basket	"Bottom basket" → Page 16
4	Dispenser for special salt	Add special salt to the dispenser for special salt. → "Water softening system", Page 18

¹ Depending on the appliance specifications

5	Lower spray arm	The lower spray arm washes the tableware in the bottom basket. If the tableware has not been washed properly, clean the spray arms. → "Cleaning spray arms", Page 27
6	Tablet collecting tray	During the wash cycle tablets automatically fall out of the detergent dispenser into the tablet collecting tray where they can fully dissolve.
7	Top basket	"Top basket" → Page 15
8	Cutlery drawer	"Cutlery drawer" → Page 16
9	EmotionLight	Interior lighting of the appliance. → "Overview of basic settings", Page 24
10	Cutlery shelf ¹	"Cutlery shelf" → Page 17
11	Upper spray arm	The upper spray arm washes the tableware in the top basket. If the tableware has not been washed properly, clean the spray arms. → "Cleaning spray arms", Page 27
12	Intake opening	The intake opening is required for the → "Drying", Page 8.
13	Blow opening	The blow opening is required for the → "Drying", Page 8.
14	Filter system	"Filter system" → Page 26
15	Dispenser for rinse aid	Add rinse aid to the dispenser for rinse aid. → "Rinse aid system", Page 19

¹ Depending on the appliance specifications

Control panel

You can use the control panel to configure all functions of your appliance and to obtain information about the operating status.

With some buttons you can perform different functions.

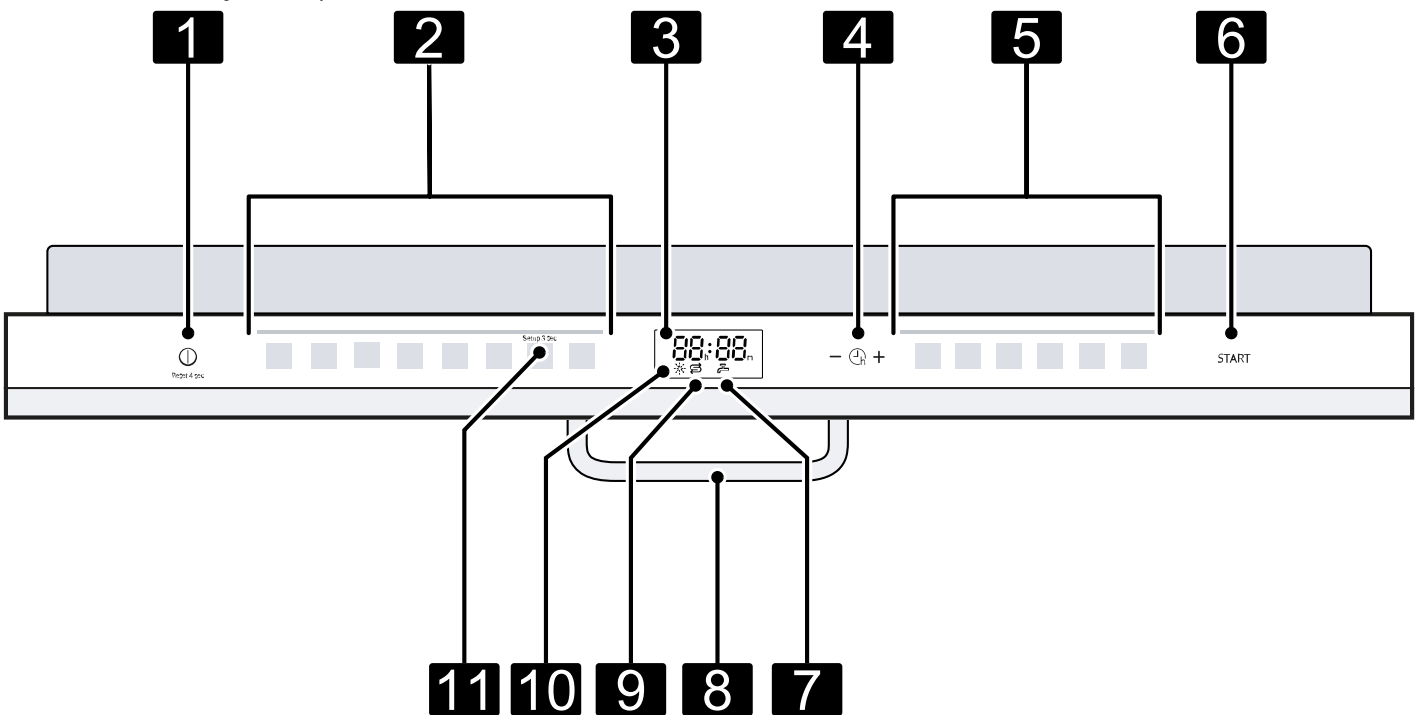

1	ON/OFF button  and reset button Reset 4 sec.	"Switching on the appliance" → Page 23 "Switching off the appliance" → Page 23 "Terminating the programme" → Page 23
2	Programme buttons	"Programmes" → Page 14







¹ Depending on the appliance specifications

3	Display	The display shows information about the remaining running time or the basic settings. You can change the basic settings via the display and the setting buttons. → "Changing basic settings", Page 25
4	Timer programming and setting buttons	"Setting timer programming" → Page 23 "Changing basic settings" → Page 25
5	Programme buttons and additional functions	Programmes → "Overview of programmes", Page 14 Additional functions → "Additional functions", Page 15
6	Start button Start	"Starting the programme" → Page 23
7	Water supply display	Display for water supply
8	Door handle ¹	Open the appliance door.
9	Special salt refill indicator	Water softening system → "Adding special salt", Page 19
10	Rinse aid refill indicator	Rinse aid system → "Adding rinse aid", Page 19
11	Setup 3 sec. button	If you press Setup 3 sec. for approx. 3 seconds, you can open the basic settings. → "Changing basic settings", Page 25

¹ Depending on the appliance specifications

Symbols on the display ¹

The display shows the following symbols depending on the model. See here for an explanation.

SYMBOL	DESCRIPTION
	If the symbol for machine care lights up on the display, run machine care. → "Machine Care  ", Page 25
	If the rinse aid refill indicator lights up on the display, top up with rinse aid. → "Adding rinse aid", Page 19
	If the special salt refill indicator lights up on the display, add special salt to the dispenser for special salt just before the programme starts. → "Adding special salt", Page 19
	When using for the first time, the symbol lights up on the display and then goes out again. The appliance has no WiFi capability ¹ .
	If you have activated the electronic start timer, the symbol lights up on the display. → "Setting timer programming", Page 23
	If the water inflow or drainage malfunctions, the symbol lights up or flashes on the display.

¹ Wi-Fi is a registered trademark of the Wi-Fi Alliance.

¹ Depending on the appliance specifications







Overview of programmes

You can find an overview of the programmes that can be selected here. Different programmes, which can be found on the control panel of your appliance, are available depending on the appliance configuration.

The running time may vary depending on the programme selected. The running time depends on the water temperature, the quantity of tableware, the level of soiling and the

Additional function selected. The running time will change if the rinse aid system is switched off or rinse aid needs to be added.

The consumption values can be found in the quick reference guide. The consumption values relate to normal conditions and a water hardness of 16 - 20 °E. Different influencing factors such as water temperature or pipe pressure may result in deviations.

PROGRAMME	USE	PROGRAMME SEQUENCE
 Intensive 70°	Tableware: • Pots and pans, non-fragile tableware and cutlery Level of soiling: • Stubborn, burned or dried-on food remnants containing starch and protein	Intensive: • Pre-Rinse • Cleaning 70 °C • Intermediate rinse • Final rinse 50 °C • Dry
AUTO Auto 45-65°	Tableware: • Mixed tableware and cutlery Level of soiling: • Common household food remnants lightly dried on	Sensor-controlled: • Optimised by sensors depending on the soiling of the washing water.
ECO Eco 50°	Tableware: • Mixed tableware and cutlery Level of soiling: • Common household food remnants lightly dried on	Most economical programme: • Pre-Rinse • Cleaning 50 °C • Intermediate rinse • Final rinse 35 °C • Drying
 Quiet 50°	Tableware: • Mixed tableware and cutlery Level of soiling: • Common household food remnants lightly dried on	Reduced noise: • Pre-Rinse • Cleaning 50 °C • Intermediate rinse • Final rinse 35 °C • Dry
 Glass 40°	Tableware: • Delicate tableware, cutlery, temperature-sensitive plastics, glasses and stemware Level of soiling: • Lightly adhering fresh food remnants	Particularly gentle: • Pre-Rinse • Cleaning 40 °C • Intermediate rinse • Final rinse 50 °C • Dry
 Quick 1h 65°	Tableware: • Mixed tableware and cutlery Level of soiling: • Common household food remnants lightly dried on	Time-optimised: • Cleaning 65 °C • Intermediate rinse • Final rinse 69 °C • Dry
 Quick 45°	Tableware: • Delicate tableware, cutlery, temperature-sensitive plastics and glasses Level of soiling: • Lightly adhering fresh food remnants	Time-optimised: • Cleaning 45 °C • Intermediate rinse • Final rinse 50 °C
 PreRinse	Tableware: • All types of dishes Level of soiling: • Cold rinsing, intermediate cleaning	Cold rinsing: • Pre-Rinse
 Machine Care	Use only if appliance is unloaded.	Machine Care 70 °C

Note: The relatively long running time in the Eco 50 ° programme is due to longer soaking and drying times. This results in optimal consumption values.

Information for test institutes

Test institutes are provided with information for comparability tests, e.g. according to EN60436.

These are the conditions for conducting the tests, however they are not the results or consumption values.



Request by e-mail to:



dishwasher@test-appliances.com

The product number (E-Nr.) and the production number (FD) are required here. They can be found on the rating plate on the appliance door.

Additional functions

You can find an overview of the additional functions that can be selected here. Different additional functions, which can be found on the control panel of your appliance, are available depending on the appliance configuration.

ADDITIONAL FUNCTION	USE
 Quick Plus	<ul style="list-style-type: none"> The run time is shortened by 15% to 75% depending on the rinse programme. Energy and water consumption are increased.
 Half Load	<ul style="list-style-type: none"> Switch on with small loads. It is recommended adding less detergent to the detergent dispenser than for a full machine load. The run time is shortened. Energy and water consumption are reduced.

ADDITIONAL FUNCTION	USE
 IntensiveZone	<ul style="list-style-type: none"> Switch on with mixed loads containing tableware with different soiling levels, e.g. place very soiled pots and pans in the bottom basket and normally soiled tableware in the upper basket. The spray pressure in the bottom basket is increased and the maximum programme temperature held longer. This will increase the run time and energy consumption.
 ExtraDry	<ul style="list-style-type: none"> For a better drying result the final rinse temperature is increased and the drying phase extended. Especially suitable for drying plastic parts. There is a slight increase in energy consumption and the run time is extended.

Features

You can find an overview of the possible features of your appliance and how to use them here.

These features depend on the model of your appliance.

Top basket

Arrange cups, glasses and small items of tableware in the top basket.

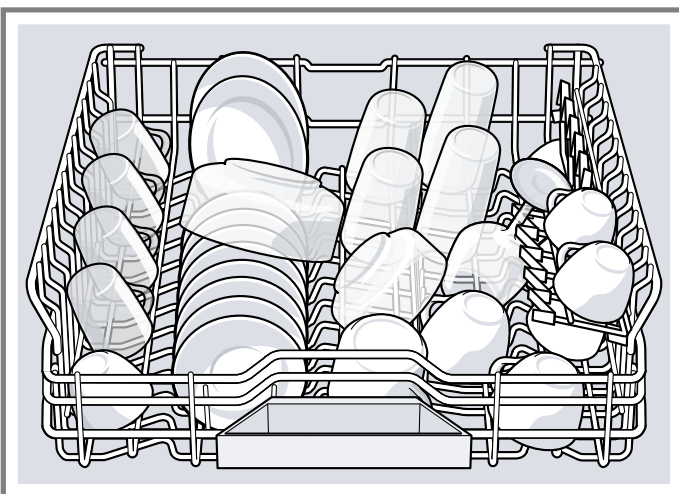

You can adjust the height of the top basket to make room for larger items of tableware.

Adjusting top basket with side levers

To wash large items of tableware in the baskets, adjust the shelf position of the top basket.

1. Pull out the top basket.
2. To prevent the basket from suddenly dropping down, hold the side of the basket by the top edge.
3. Press in the levers on the right and left on the outside of the basket.

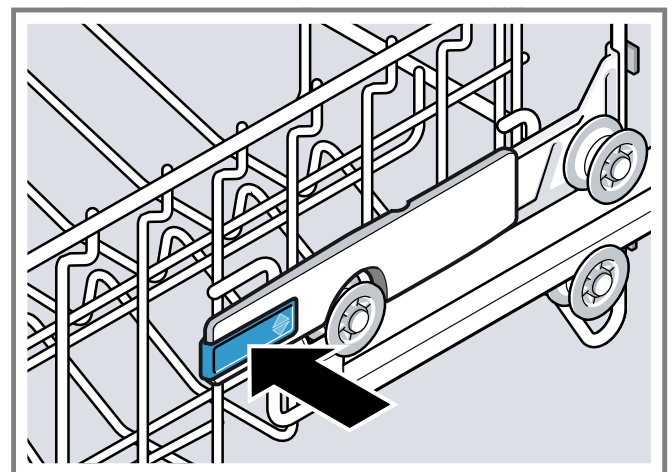

4. Raise or lower the basket evenly to the right level.

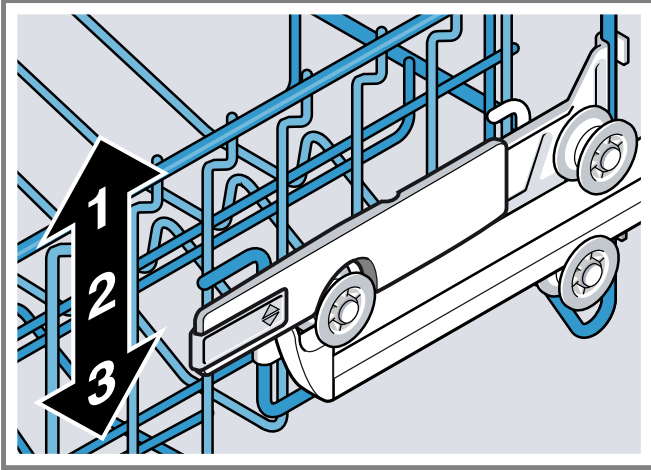

Check that the basket is level on both sides.

5. Release the levers.
- ✓ The basket clicks into position.
6. Slide the basket back in.

Bottom basket

Arrange pans and plates in the bottom basket.

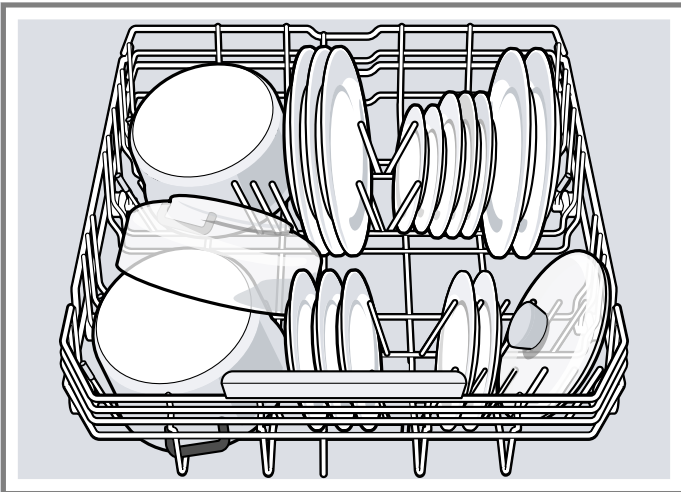

Large plates up to a diameter of 34 cm can be arranged in the bottom basket as shown.

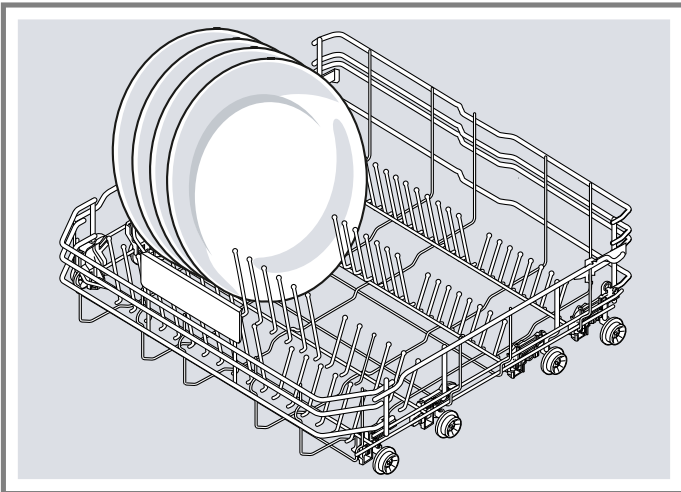

Cutlery drawer

Arrange cutlery in the cutlery drawer.

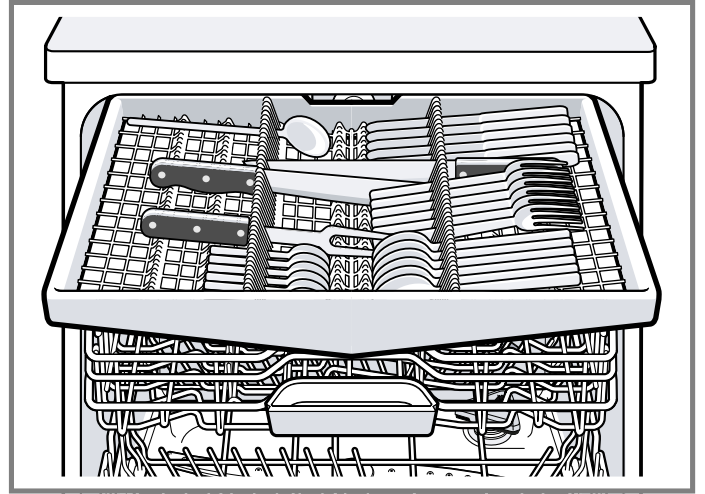

Arrange cutlery with the points and sharp edges downwards.

You can reorganise the cutlery drawer to make more space for longer/wider items of cutlery.

Reorganising cutlery drawer

You can fold down the side shelves and front prongs to make more space for longer/wider items of cutlery.

1. To fold down a side shelf, push the lever forwards ① and fold down the side shelf ②.

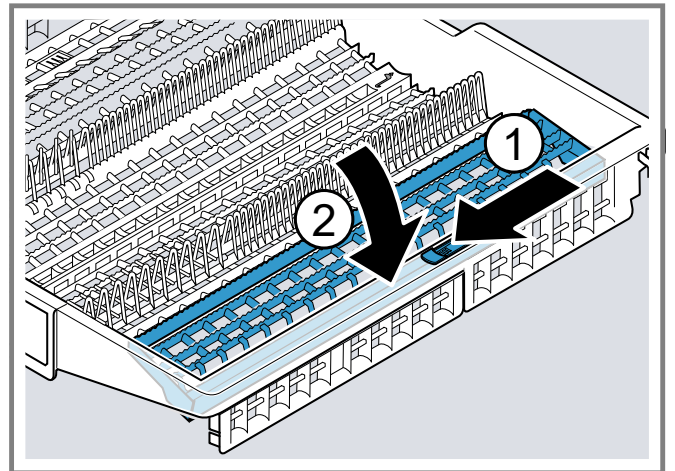

2. To fold down the front prongs, push the lever forwards and fold down the prongs ①.

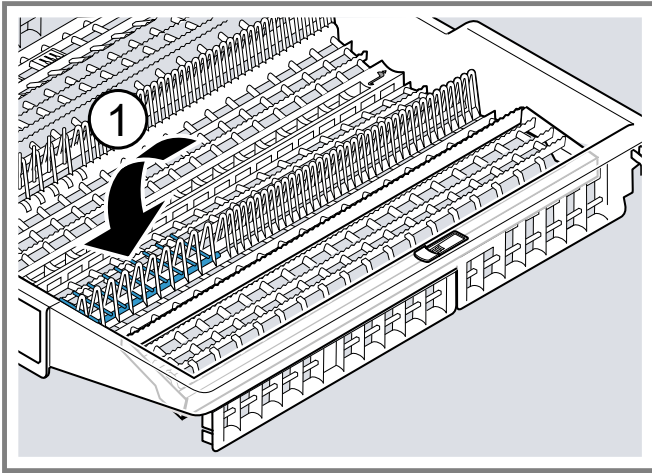

Tip

If you want to return the cutlery drawer to the original position, fold the side shelf back up until it clicks into position.

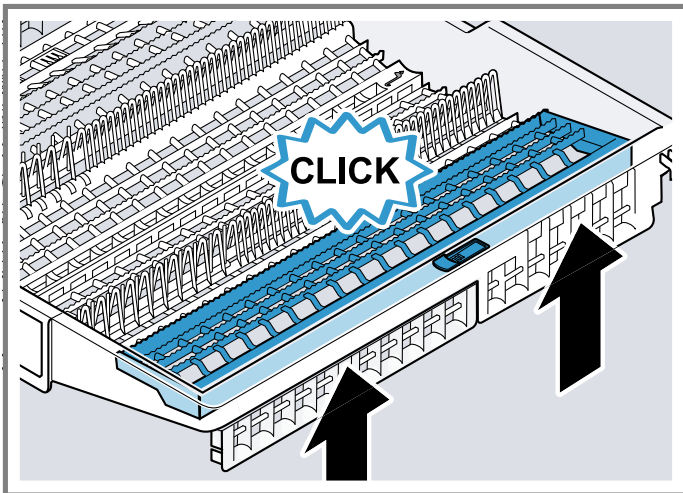

Etagere

Use the cutlery shelf and space underneath for small cups and glasses or for large items of cutlery, e.g. cooking spoons or serving cutlery.

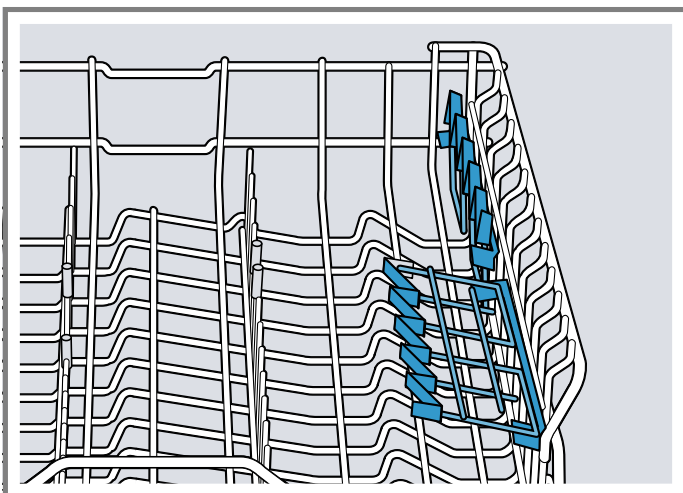

If you do not need the cutlery shelf, you can fold it up.

Folding prongs

Use the folding prongs to position tableware securely, e.g. plates.

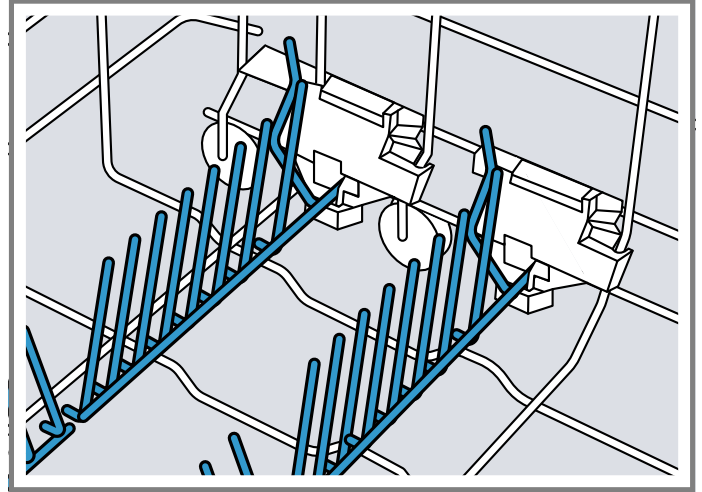

You can fold the prongs down to position pans, bowls and glasses better.¹

Folding down prongs¹

If you do not need the prongs, fold them down.

1. Push the lever forwards ① and fold down the prongs ②.

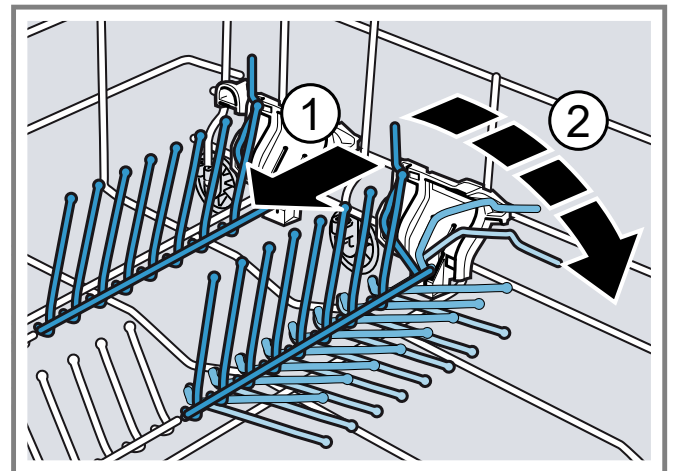

2. To use the prongs again, fold them back up.
 - ✓ The prongs audibly click into position.

¹ Depending on the appliance specifications

Basket heights

Set the baskets at the right height.

Appliance height 86.5 cm with cutlery drawer

LEVEL	TOP BASKET	BOTTOM BASKET
1 max. ø	18 cm	33 cm/"34 cm" → Page 16
2 max. ø	20.5 cm	30.5 cm
3 max. ø	23 cm	28 cm

Before first use

Performing the initial configuration

On initial start-up or after a reset to the factory settings, you will need to make settings.

Requirement: "The appliance has been installed and connected." → Page 9

1. "Add special salt." → Page 19
2. "Add rinse aid." → Page 19
3. "Switch on the appliance." → Page 23

4. "Setting the water softening system." → Page 18
5. "Set the amount of rinse aid to be dispensed." → Page 20
6. "Add detergent" → Page 20.
7. Start the Programme with the highest cleaning temperature without tableware.

To remove any marks from water or other residues, we recommend you operate the appliance without tableware before using it for the first time.

Tip: You can change these settings and other Basic settings at any time.

Water softening system

Hard water leaves limescale on the tableware as well as the washing tank, and parts of the appliance may become blocked.

To ensure good dishwashing results, you can treat the water with special salt and the water softening system. To avoid damage to the appliance, water with a hardness above 9 °E must be softened.

Overview of water hardness settings

You can find an overview of the water hardness values that can be selected here.

You can find out how hard your water is from your local water company or by using a water hardness tester.

WATER HARDNESS °E	HARDNESS RANGE	MMOL/L	SETTING VALUE
0 - 8	Soft	0 - 1.1	H:00
9 - 10	Soft	1.2 - 1.4	H:01
11 - 12	Medium	1.5 - 1.8	H:02
13 - 15	Medium	1.9 - 2.1	H:03
16 - 20	Medium	2.2 - 2.9	H:04
21 - 26	Hard	3.0 - 3.7	H:05
27 - 38	Hard	3.8 - 5.4	H:06
39 - 62	Hard	5.5 - 8.9	H:07

Note: Set the water hardness determined on your appliance. → "Setting the water softening system", Page 18



With a water hardness of 0 - 8 °E you can dispense with special salt for dishwashers and switch off the water softening system.

→ "Switching off the water softening system", Page 19

Setting the water softening system

Set the water hardness on your appliance.

1. Determine the water hardness and the appropriate setting value.
→ "Overview of water hardness settings", Page 18

2. Press .
3. To open the basic settings, press **Setup 3 sec.** for 3 seconds.
 - ✓ The display shows H:xx.
 - ✓ The display shows **set**.
4. Press  or  repeatedly until the right water hardness has been set.
The value H:04 is set at the factory.
5. To save the settings, press **Setup 3 sec.** for 3 seconds.

Special salt

You can use special salt to soften water.

Adding special salt

If the special salt refill indicator lights up, add special salt to the dispenser for special salt just before the programme starts. The consumption of special salt depends on the water hardness. The higher the water hardness, the greater the consumption of special salt.

ATTENTION!

- Detergent may damage the water softening system.
 - Only fill the dispenser of the water softening system with special dishwasher salt.
- Special salt for dishwashers can damage the tub due to corrosion.
 - To make sure that any special salt that escapes is washed out of the tub, add the special salt to the dispenser for special salt immediately before the programme starts.

1. Unscrew the lid of the dispenser for special salt and remove.
2. On initial start-up: Fill the dispenser right up with water.
3. **Note:** Only use special salt for dishwashers. Do not use salt tablets. Do not use table salt.

Add the special salt to the dispenser.

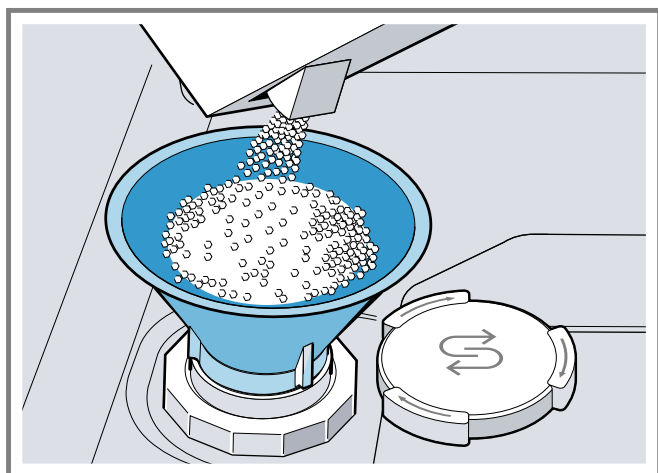

Fill the dispenser right up with special salt. The water in the dispenser is displaced and forced out.

4. Place the lid back on the dispenser and turn to close.

Switching off the water softening system

If you find the special salt refill indicator irritating, e.g. when using combined detergents with salt replacement substances, you can switch the indicator off.

Note

To avoid damage to the appliance, only switch off the water softening system in the following cases:

- The water hardness is max. 26 °E and you are using a combined detergent with salt replacement substances. According to the manufacturers, combined detergents with salt replacement substances can generally only be used up to a water hardness of 26 °E without adding special salt.
- The water hardness is 0 - 8 °E. You do not need to use special salt.

1. Press .
2. To open the basic settings, press **Setup** 3 sec. for 3 seconds.
 - ✓ The display shows H:xx.
 - ✓ The display shows **set**.
3. Press **—** or **+** repeatedly until the display shows H:00.
4. To save the settings, press **Setup** 3 sec. for 3 seconds.
 - ✓ The water softening system is switched off and the salt refill indicator is deactivated.

Regeneration of the water softening system

In order to obtain fault-free function of the water softening system, the appliance performs regeneration of the water softening system at regular intervals.

Regeneration of the water softening system takes place before the end of the main rinse cycle in all programmes. It will increase the run time and consumption values, e.g. water and electricity.

Overview of consumption values with regeneration the water softening system

Here you can find an overview of the maximum additional running time and consumption values during regeneration of the water softening system.

Regeneration of the water softening system after x washing programmes	6
Additional running time in minutes	7
Additional water consumption in litres	5
Additional power consumption in kWh	0.05

The consumption values specified are laboratory measurements determined in accordance with the currently applicable standard using the Eco 50° programme and with the factory value of the water hardness set to 16 - 20 °E.

Rinse aid system

Rinse aid

For optimum drying results, use rinse aid. Only use rinse aid for domestic dishwashers.

Adding rinse aid

If the rinse aid refill indicator lights up, top up with rinse aid. Only use rinse aid for domestic dishwashers.

1. Press the catch on the lid of the dispenser for rinse aid ① and lift ②.

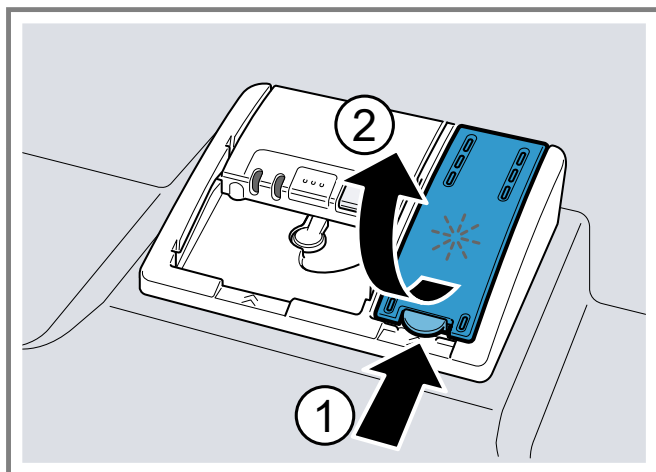

2. Add rinse aid up to the max mark.

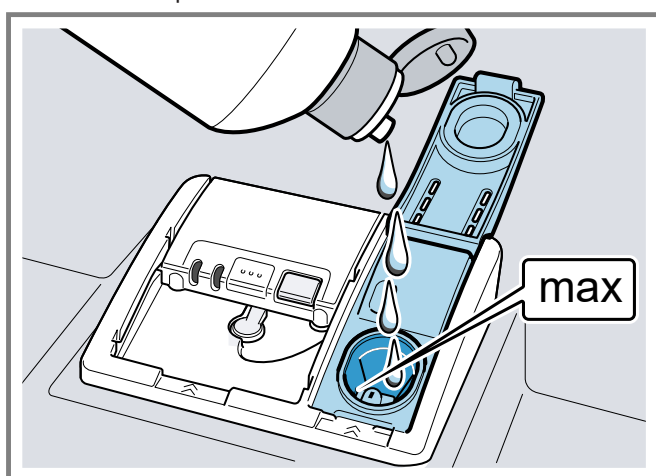

3. If rinse aid spills out, remove it from the tub.
Spilled rinse aid can cause excessive frothing during the wash cycle.
4. Close the lid of the dispenser for rinse aid.
✓ The lid clicks into position.

Setting the amount of rinse aid

If there are streaks or water marks on tableware, change the amount of rinse aid.

1. Press \odot .
2. To open the basic settings, press **Setup** 3 sec. for 3 seconds.
 - ✓ The display shows H:xx.
 - ✓ The display shows **set**.
3. Press **Setup** 3 sec. repeatedly until the display shows the value r:05 set at the factory.
4. Press $-$ or $+$ repeatedly until the right amount of rinse aid has been set.
 - A low setting adds less rinse aid during the wash cycle and reduces streaking on tableware.
 - A higher setting adds more rinse aid during the wash cycle, reduces water marks and improves the drying result.
5. To save the settings, press **Setup** 3 sec. for 3 seconds.

Switching the rinse aid system off

If you find the rinse aid refill indicator irritating, e.g. when using combined detergents with a rinse aid component, you can switch the rinse aid system off.

Tip: The function of rinse aid is limited with combined detergents. You will generally get better results using rinse aid.

1. Press \odot .
2. To open the basic settings, press **Setup** 3 sec. for 3 seconds.
 - ✓ The display shows H:xx.
 - ✓ The display shows **set**.
3. Press **Setup** 3 sec. repeatedly until the display shows the value r:00 set at the factory.
4. Press $-$ or $+$ repeatedly until the display shows r:00.
5. To save the settings, press **Setup** 3 sec. for 3 seconds.
 - ✓ The rinse aid system is switched off and the rinse aid refill indicator is deactivated.

Detergent

Suitable detergents

Only use detergents that are suitable for dishwashers. Both separate and combined detergents are suitable. For optimum washing and drying results, use separate detergent, adding "Special salt" → *Page 19* and "Rinse aid" → *Page 19* separately.

Modern, powerful detergents mainly use a low-alkaline formulation with enzymes. Enzymes break down starch and remove protein. Oxygen-based bleaching agents are generally used to remove coloured marks, e.g. tea or ketchup.

Note: Follow the manufacturer's instructions for each detergent.

Tabs

Tabs are suitable for all cleaning functions and do not need to be measured out.

With shorter programmes tabs sometimes do not dissolve entirely and leave residues of detergent. This may impair the cleaning effect.

Powder detergent

Powder detergent is recommended for shorter programmes. The dosage can be adjusted to the level of soiling.

Liquid detergent

Liquid detergent works faster and is recommended for shorter programmes without PreRinse. Sometimes liquid detergent may leak out despite the detergent dispenser being closed. This is not a fault and is non-critical if you remember the following:

- Only choose a programme without PreRinse.
- Do not select timer programming for starting the programme.

The dosage can be adjusted to the level of soiling.

Separate detergents

Separate detergents are products that do not contain components other than detergent, e.g. powder detergent or liquid detergent.

With powder and liquid detergent the dosage can be individually adjusted to the level of soiling of the tableware. For better washing and drying results and to avoid damage to the appliance, please additionally use "Special salt" → Page 19 and "Rinse aid" → Page 19.

Combined detergent

Besides conventional separate detergents, a number of products are available with additional functions. These products contain not only detergent but also rinse aid and salt replacement substances (3in1) and, depending on the combination (4in1, 5in1, ...), additional components such as glass protection or stainless steel cleaner. According to the manufacturers, combined detergents generally only function up to a water hardness of 26 °E. With a water hardness above 26 °E you will need to add special salt and rinse aid. For the best washing and drying results we recommend using special salt and rinse aid from a water hardness of 17 °E. If you are using combined detergent, the washing programme is adjusted automatically to ensure the best possible washing and drying result.

Unsuitable detergents

Do not use detergent which could cause damage to the appliance or present a risk to health.

Hand washing-up liquid

Hand washing-up liquid can cause increased frothing and damage the appliance.

Detergent containing chlorine

Chlorine residue on tableware may present a risk to health.

Information on detergents

Follow the instructions on detergents in everyday use.

- Detergents marked as "organic" or "ecological" (environmentally friendly) generally contain lower levels of active agents or completely dispense with certain substances. The cleaning effect may be restricted here.
- Set the rinse aid and the water softening system to the separate detergent or combined detergent in use.
- According to the manufacturers, combined detergents with salt replacement substances can only be used up to a certain water hardness, usually 26 °E, without adding special salt. For the best washing and drying results we recommend using special salt from a water hardness of 17 °E.
- To prevent sticking, only touch detergents in a water-soluble pouch with dry hands and only ever place them in a dry detergent dispenser.
- Even if the rinse aid and special salt refill indicators light up, washing programmes will run properly with combined detergents.
- The function of rinse aid is limited with combined detergents. You will generally get better results using a separate rinse aid.
- Use tablets with a special drying performance.

Adding detergent

1. To open the detergent dispenser, press the locking latch.
2. Add the detergent to the dry detergent dispenser.

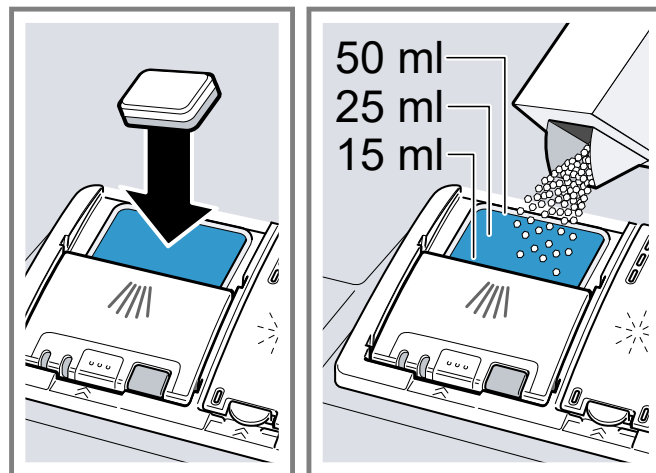

If you are using tablets, one is enough. Insert the tablets in a horizontal position.

If you are using powder or liquid detergent, follow the manufacturer's instructions and quantities for dosage in the detergent dispenser.

20 ml – 25 ml detergent is sufficient for normal soiling. If tableware is only lightly soiled, slightly less than the amount of detergent specified is usually sufficient.

3. Close the lid of the detergent dispenser.

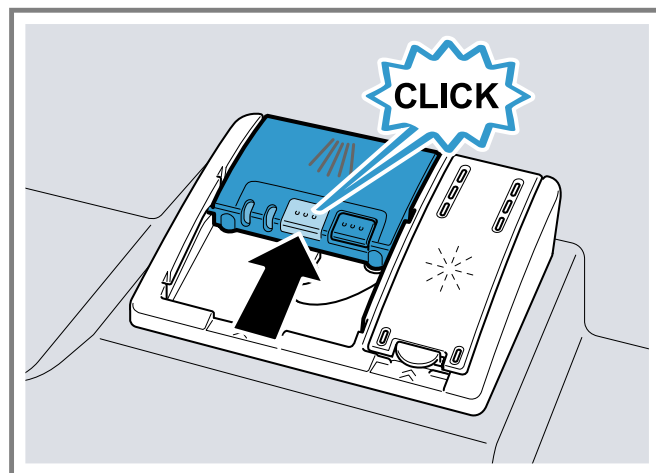

- ✓ The lid clicks into position.
- ✓ The detergent dispenser will open automatically at the optimum time during the programme. Powder or liquid detergent will spread around the washing tank and dissolve there. Tablets will fall into the tablet collecting tray and dissolve in the right dosage. In order to ensure that tablets can dissolve evenly, do not place any other objects in the tablet collecting tray.

Tip: If you use powder detergent and select a program with pre-rinse, you can also add a little detergent to the interior door of the appliance.

Tableware

Only clean tableware that is suitable for dishwashers.

Note: Decorated glassware and parts made of aluminium or silver may fade or discolour with dishwashing. Delicate types of glass may turn cloudy after a few washing cycles.

Damage to glass and tableware

Only put glasses and china in the dishwasher if it is marked as dishwasher-safe by the manufacturer. Avoid damage to glass and tableware.

CAUSE	RECOMMENDATION
<p>The following tableware is not dishwasher-safe:</p> <ul style="list-style-type: none"> • Items of cutlery and tableware made from wood • Decorated glassware, antique and hand-crafted tableware • Plastic parts not resistant to heat • Tableware made from copper or tin • Tableware soiled with ash, wax, lubricating grease or paint • Very small items of tableware 	<p>Only put tableware in the dishwasher if it is marked as dishwasher-safe by the manufacturer.</p>
<p>The chemical composition of detergent causes damage.</p>	<p>Use a detergent marked by the manufacturer as gentle on tableware.</p>
<p>Highly caustic alkaline or highly acidic cleaning solutions, in particular commercial or industrial cleaners, are not safe to use in the dishwasher with aluminium.</p>	<p>If you are using highly caustic alkaline or highly acidic cleaning agents, in particular commercial or industrial cleaning agents, do not put aluminium parts in the dishwasher interior.</p>
<p>The water temperature of the programme is too high.</p>	<p>Select a programme with lower temperatures. After the programme has ended, take glassware and cutlery out of the appliance without delay.</p>

Arrange tableware

Arrange tableware correctly to optimise the dishwashing result and prevent damage to both the appliance and tableware.

Tips

- Using the appliance allows you to save energy and water compared to washing-up by hand.
- To save energy and water, load the machine with the number of place settings specified (standard load with tableware and cutlery).

- For better washing and drying results, position items with curves or recesses at an angle so water can run off.

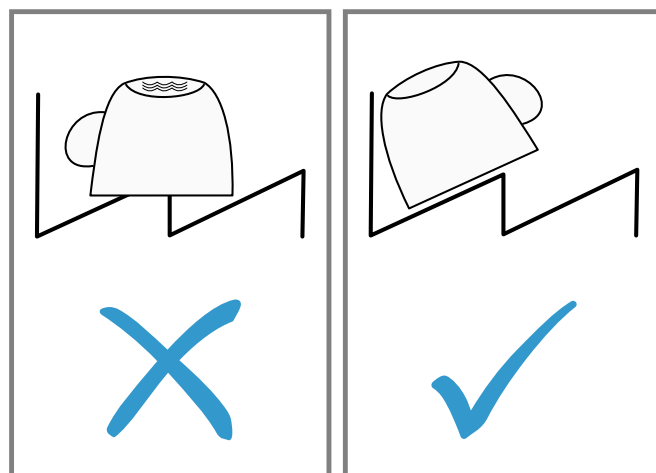

1. Remove large remnants of food from tableware.
To save resources, do not pre-rinse tableware under running water.
2. Observe the following when arranging tableware:
 - Put heavily soiled tableware in the bottom basket, e.g. pans. The more powerful the spray jet, the better the dishwashing result will be.
 - To prevent damage to tableware, arrange it so it is stable and cannot tip over.
 - To prevent injury, arrange cutlery with the points and sharp edges facing down.
 - Position containers with the openings facing down so no water can collect in them.
 - Do not block the spray arms - make sure that they can turn freely.
 - Do not place small parts in the tablet collecting tray and do not block it with tableware so as not to obstruct the lid of the detergent dispenser.

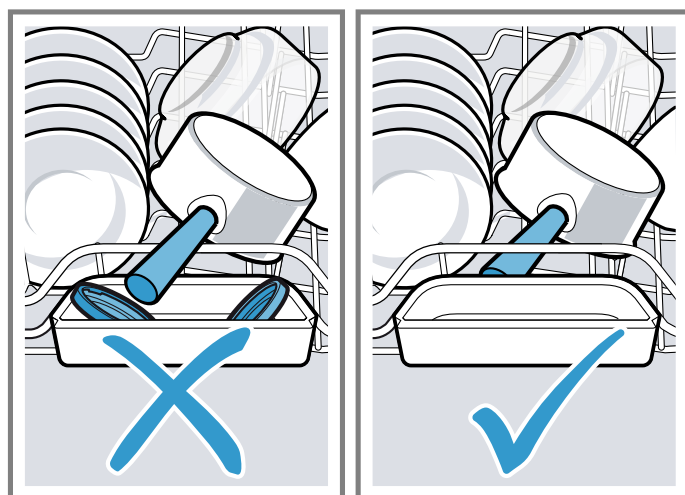

Removing tableware

WARNING **Risk of injury!**

- Hot tableware can cause burns to the skin. When hot, tableware is sensitive to shock, may crack and can result in injury.
- When the programme has ended, do not empty the appliance until the tableware has cooled down for a while.

Basic operation

Switching on the appliance

- Press .
The Eco 50° programme is set by default. The Eco 50° programme is especially environmentally friendly and ideal for normally soiled tableware. It is the most efficient programme for the combination of energy/water consumption for this type of tableware and evidences conformity with the EU Ecodesign Directive. If you do not perform any actions on the appliance for 10 minutes, the appliance will automatically switch off.

Setting a programme

To adjust the washing programme to the soiling level of the tableware, select a suitable programme.

- Press the right programme button.
- ✓ The programme is set and the programme button flashes.
- ✓ The remaining running time of the programme appears on the display.

Setting additional functions





You can set additional functions to complete the washing programme selected.



Note: The additional functions which can be used depend on the programme selected.

- Press the button for the relevant additional function.
→ "Additional functions", Page 15
- ✓ The additional function is set and the additional function button flashes.

Setting timer programming

You can delay the start of the programme by up to 24 hours.

1. Press  or .
- ✓ "00h:01m" appears on the display.
2. Use  or  to set the required start time for the programme.
3. Press Start.
- ✓ This activates time preselection.

Tip: To deactivate timer programming, press  or  repeatedly until "00h:00m" appears in the display.

Starting the programme

- Press Start.
- ✓ The programme has ended when the display shows "00h:00m".



1. To prevent water dripping on the tableware, unload it starting at the bottom and working up.
2. Check the washing tank and accessories for soiling and clean if necessary.
→ "Cleaning and servicing", Page 25

Notes

- If you want to add more tableware while the appliance is running, do not use the tablet collecting tray as a handle for the top basket. You might touch the partially dissolved tablet.
- You can only change a programme when running if you cancel it.
→ "Terminate programme", Page 23
- The appliance switches off automatically 1 minute after the end of the programme to save energy. If you open the appliance door immediately after the programme has ended, the appliance will switch off after 4 seconds.

Interrupting programme

Note: When you open the appliance door once the appliance has heated up, leave the door slightly ajar for a few minutes and then close it. This will help prevent excess pressure building up in the appliance and stop the appliance door bursting open.

1. Open the appliance door carefully.
2. Press .
- ✓ The programme is saved and the appliance switches off.
3. Press  to resume the programme.
4. Close the appliance door.

Terminate programme

To end a programme early or to switch from a programme that has already started, you will need to cancel it first.

1. Open the appliance door.
2. Press **Reset 4 sec.** for approx. 4 seconds.
3. Close the appliance door.
- ✓ The programme is cancelled and ends after approx. 1 minute.

Switching off appliance

1. Please note the information on "Safe use" → Page 8.
2. Press .

Tip: If you press  during the wash cycle, the programme currently running will be interrupted. When you switch the appliance back on, the programme continues automatically.

Basic settings

You can configure the basic settings for your appliance to meet your needs.

Overview of basic settings

The basic settings depend on the features of your appliance.

BASIC SETTING	DISPLAY TEXT	SELECTION	DESCRIPTION
Water hardness	H:04 ¹	H:00 - H:07	Set the water softening system to your water hardness. Level H:00 switches the water softening system off.
Rinse aid dispensing	r:05 ¹	r:00 - r:06	Set the amount of rinse aid to be dispensed. Switch the rinse aid system off with level r:00.
Sensor setting	SE:00 ¹	SE:00 - SE:02	Set the water sensor for identifying soiling. → "Sensors", Page 9
Extra Dry	d:00 ¹	d:00 - d:01	The temperature is increased during the final rinse, which improves the drying result. This may increase the run time slightly. Note: Not suitable for delicate items of tableware. Switch Extra Dry on "d:01" or off "d:00".
Hot water	A:00 ¹	A:00 - A:01	Set cold water or hot water connection. Only set the appliance to hot water if this can be prepared with little energy and a suitable installation is available, e.g. solar heating system with circulation line. The water temperature should be at least 40 °C and max. 60 °C. Switch hot water on "A:01" or off "A:00".
Interior lighting	EL:02 ¹	EL:00 - EL:02	Interior light. <ul style="list-style-type: none"> With the setting "EL:00" the interior light is switched off. With the setting "EL:01", the interior light can be activated via the ON/OFF  button. With the setting "EL:02", the interior light goes on when you open the appliance door. When the appliance door is opened, the interior lighting switches off automatically after 10 minutes.
Time-beam-on-floor	S:01 ¹	S:00 - S:01	Switch Time-beam-on-floor on or off. While the programme is running, status information is projected onto the floor below the appliance door relating to timer programming, the programme or the time remaining. If the base panel is pulled forwards or if the appliance is installed at eye level with the cabinet front fitted flush, the display is not visible. Level "S:00" switches the Time-beam-on-floor off.
Start programme	SP:01 ¹	SP:00 - SP:01	Set a default programme for when the appliance is switched on. <ul style="list-style-type: none"> With the setting "SP:00", the last programme selected is set by default when the appliance is switched on. With the setting "SP:01", the Eco 50° programme is set by default when the appliance is switched on.
Tone volume	SL:02 ¹	SL:00 -SL:03	Adjustment of tone volume. Level "SL:00" switches the signal tone off.



¹ Factory setting (may vary according to model)

BASIC SETTING	DISPLAY TEXT	SELECTION	DESCRIPTION
Button volume	bL:02 ¹	bL:00 - bL:03	Set the button volume during operation. Level "bL:00" switches the button tones off.
Factory setting	rE:	Start with + Y:ES Confirm with +	Restore changed settings to the factory settings. The settings for initial start-up must be configured.

¹ Factory setting (may vary according to model)

Changing basic settings

1. Open the appliance door.
2. Press .
3. To open the basic settings, press Setup 3 sec. for 3 seconds.
 - ✓ The display shows H:xx.
 - ✓ The display shows **set**.

4. Press Setup 3 sec. repeatedly until the display shows the required setting.
5. Press  or  repeatedly until the display shows the right value.

You can change several settings.
6. To save the settings, press Setup 3 sec. for 3 seconds.
7. Close the appliance door.

Cleaning and servicing

To keep your appliance working efficiently for a long time, it is important to clean and maintain it carefully.

Cleaning the tub

WARNING

Risk of harm to health!

- Using detergents containing chlorine may result in harm to health.
- Never use detergents containing chlorine.

1. Remove any coarse soiling in the interior with a damp cloth.
2. Add detergent to the detergent dispenser.
3. Select the programme with the highest temperature.
4. "Start the programme without tableware." → Page 23

Machine Care

Deposits, e.g. from remnants of food and limescale, can cause your appliance to malfunction. To avoid such faults and reduce odours, we recommend cleaning your appliance at regular intervals.

Machine Care combined with machine care products and machine cleaners is the right programme for the care of your appliance.

PHASE	REMOVAL OF	DETERGENT	PLACEMENT
1	Grease and limescale	Liquid machine care product or machine descaler in powder form.	Appliance interior, e.g. bottle hung in the cutlery basket or powder in the interior.
2	Food remnants and deposits	Machine cleaner	Detergent dispenser

To ensure optimum cleaning performance, the programme doses the detergents independently of each other during the relevant cleaning phase. Correct placement of the detergents is necessary here.

Run Machine Care without tableware if the indicator for Machine Care lights up on the control panel or if advised to do so by the display. The indicator will go out after you have

Cleaning products

Only use suitable cleaning products to clean your appliance. → "Safe use", Page 8

Tips on appliance care

Follow the tips on appliance care to make sure your appliance functions properly at all times.

ACTION	BENEFIT
Wipe the door seals, the front of the dishwasher and the control panel regularly using a damp cloth and washing-up liquid.	This ensures the parts of the appliance will remain clean and hygienic.
If the appliance is not going to be used for a while, leave the door slightly ajar.	This will prevent unpleasant odours.

Machine Care is a programme which removes various deposits in one washing cycle. Cleaning takes place in two phases:

run Machine Care. If your appliance does not have a reminder function, we recommend performing Machine Care every 2 months.

Running Machine Care

Notes

- Run the Machine Care programme without any tableware in the dishwasher.

- Only use machine care products and machine cleaners specially designed for dishwashers.
- Make sure that there are no aluminium parts, e.g. extractor hood grease filters or aluminium pans, in the interior of the appliance.
- If you have not run Machine Care after 3 washing cycles, the indicator for Machine Care will go out automatically.
- For optimum cleaning performance, ensure the correct placement of cleaners.
- Follow the safety instructions given on the packagings of the machine care products and machine cleaners.

1. Remove any coarse soiling in the interior with a damp cloth.
2. Clean the filters.
3. Place the machine care product in the appliance interior.
Only use machine care products specially designed for dishwashers.

4. Pour the machine cleaner into the detergent dispenser until it is filled completely.

Do not place any additional machine cleaner in the appliance interior.

5. Press .

6. Press Start.

✓ Machine Care is run.

✓ Once the programme has ended, the indicator for Machine Care goes out.

Filter system

The filter system removes coarse soiling from the dishwashing cycle.

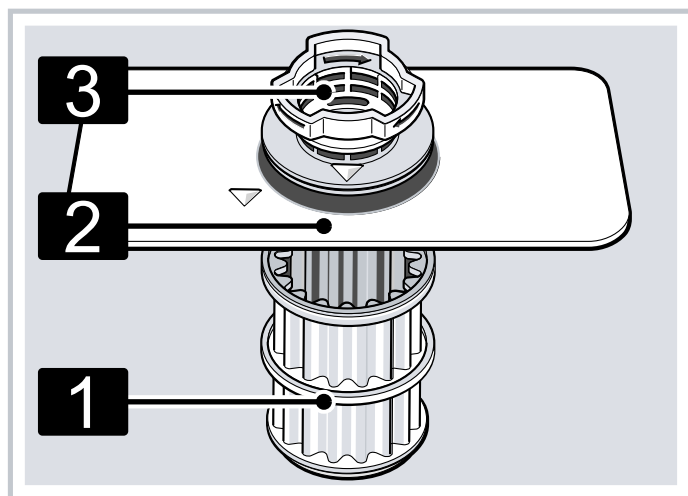

1	Micro filter
2	Fine filter
3	Coarse filter

Cleaning filters

Soiling in the dishwashing water may block the filters.

1. After each wash check the filters for residue.
2. Turn the coarse filter anticlockwise ① and remove the filter system ②.
 - Check that no foreign objects fall into the sump.

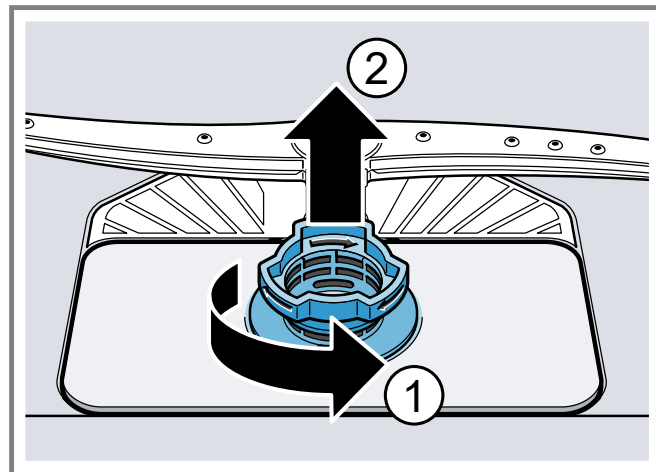

3. Pull down the micro filter to remove.

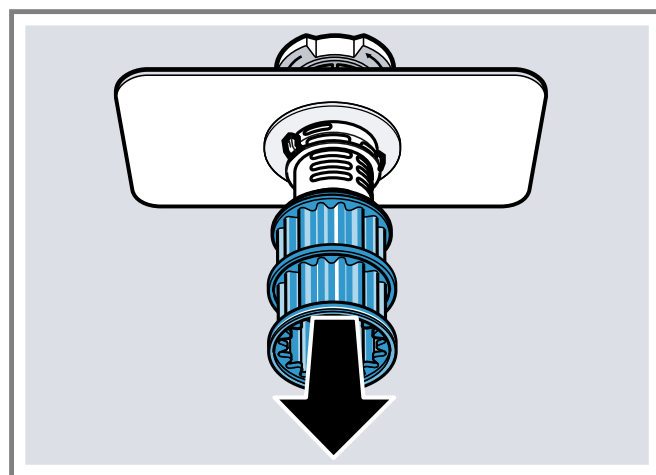

4. Press the locking catches ① together and lift the coarse filter out ②.

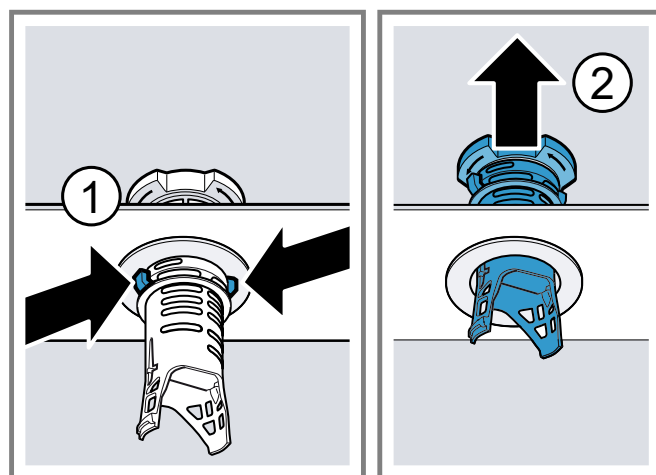

5. Clean the filter elements under running water.
Carefully clean the rim of dirt between the coarse and the fine filter.
6. Re-assemble the filter system.
Make sure that the locking catches on the coarse filter click into position.
7. Insert the filter system into the appliance and turn the coarse filter clockwise.
 - Make sure that the arrow markings match up.

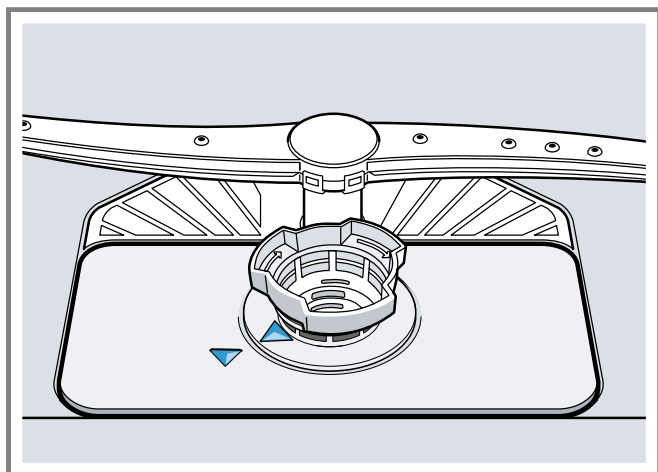

Cleaning spray arms

Limescale and soiling in the dishwashing water may block the nozzles and bearings on the spray arms. Clean the spray arms regularly.

1. Unscrew the upper spray arm ① and pull down to remove ②.

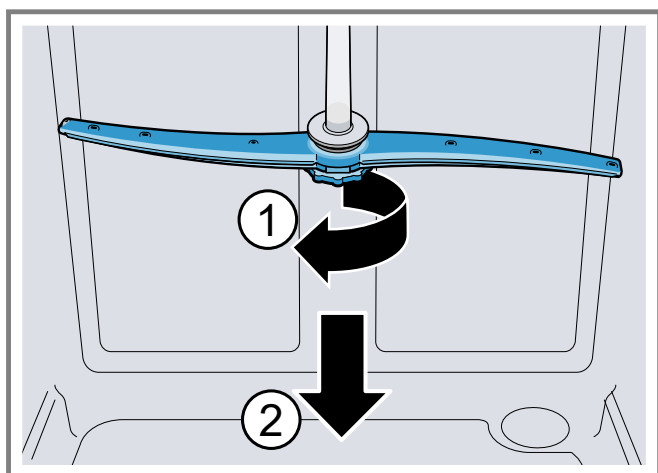

2. Pull up the lower spray arm to remove.

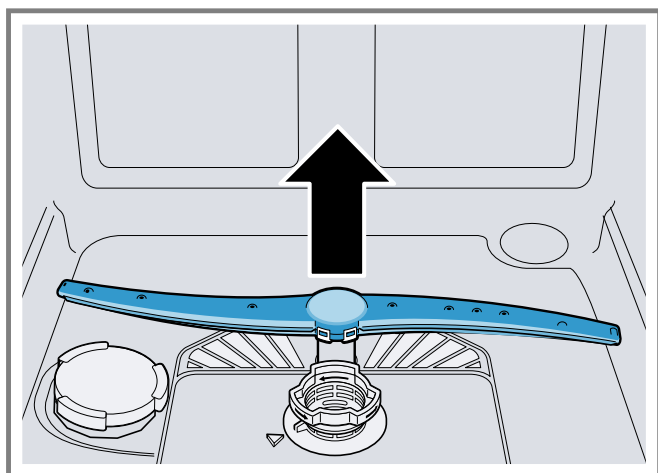

3. Check the outlet nozzles on the spray arms for blockages under running water and remove any foreign bodies.
4. Insert the lower spray arm.
 - ✓ The spray arm clicks into position.
5. Insert the upper spray arm and screw it firmly in place.

Troubleshooting

You can rectify minor faults on your appliance yourself. Read the troubleshooting information before contacting after-sales service. This will avoid unnecessary costs.

⚠ WARNING



Risk of electric shock!

- Incorrect repairs are dangerous.
- Repairs to the appliance should only be carried out by trained specialist staff.
- Only use genuine spare parts when repairing the appliance.
- If the power cord or the appliance power cable of this appliance is damaged, it must be replaced with a special power cord or special appliance power cable, which is available from the manufacturer or its Customer Service.

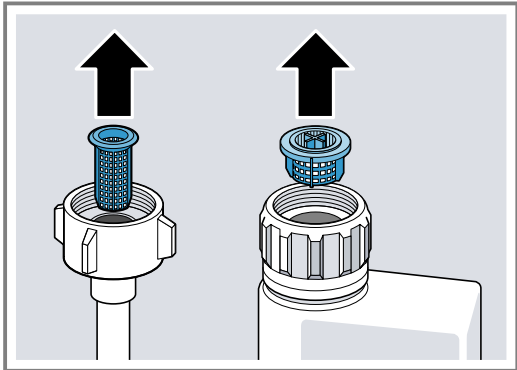
Error code / Fault display / Signal

FAULT	CAUSE	TROUBLESHOOTING
E:20-60 lights up alternately.	Appliance has detected calcified heating element.	<ol style="list-style-type: none"> 1. Descal the appliance. 2. Operate the appliance with the "water softening system" → Page 18.¹
E:21-30 will light up alternately.	Intake opening for drying is covered by items of tableware.	<ul style="list-style-type: none"> • Re-arrange the tableware in the appliance so the "intake opening for drying" → Page 11 is no longer obstructed.
E:30-00 will light up alternately.	Water protection system is activated.	<ol style="list-style-type: none"> 1. Turn off the water tap. 2. Call Customer Service.
E:31-00 will light up alternately.	Water protection system is activated.	<ol style="list-style-type: none"> 1. Turn off the water tap. 2. Call Customer Service.
E:32-00 will light up alternately or indicator for water supply lights up.	Supply hose is kinked.	<ul style="list-style-type: none"> • Install the supply hose without kinks.
	Water tap is turned off.	<ul style="list-style-type: none"> • Turn on the water tap.
	Water tap is jammed or furred up.	<ul style="list-style-type: none"> • Turn on the water tap. <p>The flow rate must be at least 10 l/min when the water supply is open.</p>
	The filters in the water connection of the supply or AquaStop hose are blocked.	<ol style="list-style-type: none"> 1. Switch off the appliance. 2. Pull out the mains plug. 3. Turn off the water tap. 4. Unscrew the water connection. 5. Remove the filter from the supply hose  <ol style="list-style-type: none"> 6. Clean the filter. 7. Re-insert the filter in the supply hose. 8. Screw the water connection back on. 9. Check the water connection for leaks. 10. Restore the power supply. 11. Switch the appliance on.
E:34-00 will light up alternately.	Water is continuously running into the appliance.	<ol style="list-style-type: none"> 1. Turn off the water tap. 2. Call Customer Service.

¹ Depending on the appliance specifications

FAULT	CAUSE	TROUBLESHOOTING
E:61-02 will light up alternately.	Wastewater pump is blocked.	<ul style="list-style-type: none"> • Clean the wastewater pump. → "Clean wastewater pump", Page 36
	Cover of the wastewater pump is loose	<ul style="list-style-type: none"> • Secure the cover of the "Wastewater pump" → Page 36 so it clicks into position.
E:61-03 will light up alternately. Water is not drained.	Wastewater hose is blocked or kinked.	<ol style="list-style-type: none"> 1. Reposition the wastewater hose without kinks. 2. Remove residues.
	Siphon connection is still sealed.	<ul style="list-style-type: none"> • Check the connection to the siphon and open if necessary.
	Cover of the wastewater pump is loose.	<ul style="list-style-type: none"> • Secure the cover of the "Wastewater pump" → Page 36 so it clicks into position.
E:90-01 will light up alternately.	Mains voltage is too low.	<p>This is not a fault on the appliance.</p> <ol style="list-style-type: none"> 1. Contact an electrician. 2. Have the mains voltage and electrical installation checked by an electrician.
E:92-40 will light up alternately.	Filters are soiled or blocked.	<ul style="list-style-type: none"> • Clean the filters. → "Cleaning filters", Page 26
<p>A different error code appears in the display window.</p> <p>E:01-00 to E:90-10</p>	A technical fault is present.	<ol style="list-style-type: none"> 1. Press . 2. Unplug the appliance or switch off the fuse. 3. Wait at least 2 minutes. 4. Insert the mains plug of the appliance in a socket or switch on the fuse. 5. Switch the appliance on. 6. If the problem occurs again: <ul style="list-style-type: none"> • Press . • Turn off the water tap. • Pull out the mains plug. • Contact Customer Service and give the error code.

Washing results

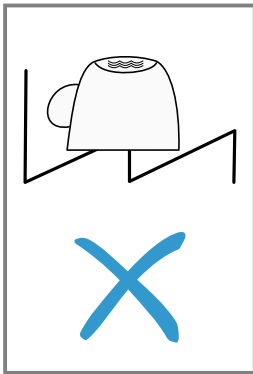
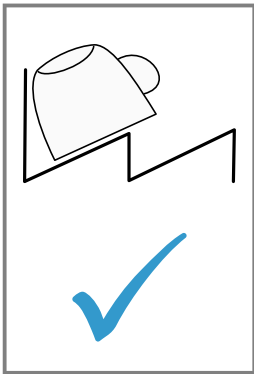
FAULT	CAUSE	TROUBLESHOOTING
Tableware is not dry.	No rinse aid used or dosage set too low.	<ol style="list-style-type: none"> 1. Add "Rinse aid" → Page 19. 2. Set the amount of rinse aid to be dispensed. → "Setting the amount of rinse aid", Page 20
	Programme or programme option has no drying phase, or the drying phase is too brief.	<ul style="list-style-type: none"> • Select a programme with drying, e.g. intensive, strong or ECO programme. <p>Some option buttons decrease the drying result, e.g. varioSpeed.</p>
	Water collects in recesses of the tableware or cutlery.	<ul style="list-style-type: none"> • Position tableware at an angle where possible. <div style="display: flex; justify-content: space-around; align-items: center;">   </div>
	The combined detergent used has a poor drying performance.	<ol style="list-style-type: none"> 1. Use rinse aid to improve drying performance.

FAULT	CAUSE	TROUBLESHOOTING
Tableware is not dry.		<ol style="list-style-type: none"> 2. Use a different combined detergent with a better drying performance.
	Extra Dry not activated to improve drying performance.	<ul style="list-style-type: none"> • Activate Extra Dry.
	Tableware removed too early or drying process not yet ended.	<ol style="list-style-type: none"> 1. Wait until the programme ends. 2. Only remove tableware 30 minutes after the programme has ended.
	Rinse aid used has a limited drying performance.	<ul style="list-style-type: none"> • Use a name-brand rinse aid. Eco products may have limited effectiveness.
Plastic tableware is not dry.	Not a fault. As plastic does not store heat so well, it also does not dry as well.	<ul style="list-style-type: none"> • No remedial action possible.
Cutlery is not dry.	Cutlery not arranged properly in the cutlery basket or cutlery drawer.	<p>Droplets can form on the cutlery contact points.</p> <ol style="list-style-type: none"> 1. "Arrange cutlery individually where possible." → <i>Page 22</i> 2. Avoid points of contact.
Appliance interior still wet after wash cycle.	Not a fault. The condensation drying principle causes water droplets in the tub – they are indeed desirable here. The moisture in the air condenses on the inside walls, runs off and is pumped out.	No action required.
Remnants of food on tableware.	Tableware is placed too close together or basket is overfilled.	<ol style="list-style-type: none"> 1. Arrange tableware with sufficient space in between. The spray jets must reach the surfaces of the tableware. 2. Avoid points of contact.
	Spray arm rotation of the lower spray arm is blocked.	<ul style="list-style-type: none"> • Arrange tableware so that it does not obstruct spray arm rotation.
	Spray arm nozzles are blocked.	<ul style="list-style-type: none"> • Clean the "Spray arms" → <i>Page 27</i>.
	Filters are soiled.	<ul style="list-style-type: none"> • Clean the filters. → <i>"Cleaning filters", Page 26</i>
	Filters are inserted incorrectly and/or not engaged.	<ol style="list-style-type: none"> 1. Insert the filters properly. → <i>"Filter system", Page 26</i> 2. Engage the filters.
	Washing programme selected too weak.	<ul style="list-style-type: none"> • Select a more intensive washing programme. → <i>"Overview of programmes", Page 14</i> • Adjust the sensitivity of the sensors. → <i>"Sensors", Page 9</i>
	Tableware has been precleaned too intensely. The sensors chose a weaker programme. Stubborn soiling cannot be entirely removed.	<ul style="list-style-type: none"> • Only remove large remnants of food and do not prerinse tableware. • Adjust the sensitivity of the sensors. → <i>"Sensors", Page 9</i>
	Tall narrow receptacles in corner areas are not rinsed adequately.	<ul style="list-style-type: none"> • Do not position tall narrow receptacles at too great an angle or in corner areas.
Top baskets on right and left are not set to same height.	<ul style="list-style-type: none"> • Set the upper basket on the left and right to the same height. → <i>"Top basket", Page 15</i> 	
Detergent residue in the appliance	Lid of the detergent dispenser is blocked by items of tableware parts and will not open.	<ol style="list-style-type: none"> 1. Arrange tableware in the top basket tableware so the tab collecting tray is not obstructed by tableware. → <i>"Arrange tableware", Page 22</i> Items of tableware are blocking the dispenser lid. 2. Do not place tableware or fragrance dispensers in the tablet collecting tray.

FAULT	CAUSE	TROUBLESHOOTING
Detergent residue in the appliance	The lid of the detergent dispenser is blocked by the tab and will not open.	<ul style="list-style-type: none"> Position the tab in the detergent dispenser crosswise, not vertically.
	Tabs are used in the quick or short programme. Dissolving time of the tab is not attained.	<ul style="list-style-type: none"> Select a more intensive "Programme" → <i>Page 14</i> or use "Powder detergent" → <i>Page 20</i>.
	Washing effect and dissolving performance are reduced after a prolonged storage time or detergent is very lumpy.	<ul style="list-style-type: none"> Change your detergent.
Water marks on plastic parts.	Due to laws of physics droplet formation on plastic surfaces is unavoidable. After drying water marks are visible.	<ul style="list-style-type: none"> Select a more intensive programme. → <i>"Overview of programmes", Page 14</i> Position tableware at an angle. → <i>"Arrange tableware", Page 22</i> Use rinse aid. → <i>"Rinse aid", Page 19</i> Set the water softening system higher. → <i>"Setting the water softening system", Page 18</i>
Wipeable or water-soluble coatings are present inside the appliance or on the door.	Detergent substances are deposited there. These coatings cannot generally be removed with chemicals.	<ul style="list-style-type: none"> Change your "detergent" → <i>Page 20</i>. Clean the appliance mechanically.
	White coating is deposited in the appliance interior.	<ol style="list-style-type: none"> Set the water softening system correctly. → <i>"Setting the water softening system", Page 18</i> In most cases you will need to increase the setting. Change your detergent if required.
	Special salt dispenser is not screwed tight.	<ul style="list-style-type: none"> Screw the special salt dispenser tight.
Stubborn white coatings are present on tableware, inside the appliance or the door.	Detergent substances are deposited there. These coatings cannot generally be removed with chemicals.	<ul style="list-style-type: none"> Change your "detergent" → <i>Page 20</i>. Clean the appliance mechanically.
	Hardness range is set incorrectly or the water hardness is too high. → <i>"Overview of water hardness settings", Page 18</i>	<ul style="list-style-type: none"> Set the Water softening system to the water hardness or add special salt.
	3in1/organic/eco detergent is not effective enough.	<ul style="list-style-type: none"> Set the Water softening system to the water hardness and use separate detergents (proprietary detergent, special salt, rinse aid).
	Too little detergent is being used.	<ul style="list-style-type: none"> Increase the amount of detergent used or change "Detergent " → <i>Page 20</i>.
	Washing programme selected too weak.	<ul style="list-style-type: none"> Select a more intensive washing programme. → <i>"Overview of programmes", Page 14</i> Adjust the sensitivity of the sensors. → <i>"Sensors", Page 9</i>
Tea residue or lipstick marks on tableware.	Washing temperature is too low.	<ul style="list-style-type: none"> Select a programme with a higher washing temperature. → <i>"Overview of programmes", Page 14</i>
	Too little detergent is being used or is unsuitable.	<ul style="list-style-type: none"> Use a suitable "Detergent " → <i>Page 20</i> and follow the manufacturer's instructions for the amount to be used.
	Tableware has been precleaned too intensely. The sensors chose a weaker programme. Stubborn soiling cannot be entirely removed.	<ul style="list-style-type: none"> Only remove large remnants of food and do not prerinse tableware. Adjust the sensitivity of the sensors. → <i>"Sensors", Page 9</i>

FAULT	CAUSE	TROUBLESHOOTING
Coloured coatings (blue, yellow, brown) that are difficult or impossible to remove are present inside the appliance or on stainless steel tableware.	The formation of films is due to substances contained in vegetables (cabbage, celery, potatoes, noodles, etc.) or tap water (manganese).	<ul style="list-style-type: none"> • Clean the appliance. You can remove deposits with "Mechanical cleaning" → <i>Page 25</i> or a machine cleaning product. It may not always be possible to completely remove deposits but they are harmless to health.
	The formation of films is due to metal components on silver or aluminium tableware.	<ul style="list-style-type: none"> • Clean the appliance. You can remove deposits with "Mechanical cleaning" → <i>Page 25</i> or a machine cleaning product. It may not always be possible to completely remove deposits but they are harmless to health.
Coloured deposits (yellow, orange, brown) that are easy to remove are present inside the appliance (mainly at the bottom).	The formation of films is due to ingredients of food remnants and tap water (limescale) "soaplike".	<ol style="list-style-type: none"> 1. Check the setting of the water softening system. → <i>"Setting the water softening system", Page 18</i> 2. Add special salt. → <i>"Adding special salt", Page 19</i> 3. If you are using combined detergents (tabs), activate the water softening system. Follow the information on detergents. → <i>"Information on detergents", Page 21</i>
Plastic parts inside the appliance are discoloured.	Plastic parts inside the appliance may become discoloured during the life of the dishwasher.	<ul style="list-style-type: none"> • Discolouration can come about and will not impair functioning of the appliance.
Plastic parts are discoloured.	Washing temperature is too low.	<ul style="list-style-type: none"> • Select a programme with a higher washing temperature. → <i>"Overview of programmes", Page 14</i>
	Tableware has been precleaned too intensely. The sensors chose a weaker programme. Stubborn soiling cannot be entirely removed.	<ul style="list-style-type: none"> • Only remove large remnants of food and do not prerinse tableware. • Adjust the sensitivity of the sensors. → <i>"Sensors", Page 9</i>
Removable streaks are present on glasses, glassware with a metallic appearance and cutlery.	Amount of rinse aid to be dispensed is set too high.	<ul style="list-style-type: none"> • Set the rinse aid system to a lower setting. → <i>"Setting the amount of rinse aid", Page 20</i>
	No rinse aid has been added.	<ul style="list-style-type: none"> • Add rinse aid. → <i>"Adding rinse aid", Page 19</i>
	Detergent residue is present in the final rinse. Lid of the detergent dispenser is blocked by tableware items and will not open fully.	<ol style="list-style-type: none"> 1. Arrange tableware in the top basket tableware so the tab collecting tray is not obstructed by tableware. → <i>"Arrange tableware", Page 22</i> Items of tableware are blocking the dispenser lid. 2. Do not place tableware or fragrance dispensers in the tablet collecting tray.
	Tableware has been precleaned too intensely. The sensors chose a weaker programme. Stubborn soiling cannot be entirely removed.	<ul style="list-style-type: none"> • Only remove large remnants of food and do not prerinse tableware. • Adjust the sensitivity of the sensors. → <i>"Sensors", Page 9</i>

FAULT	CAUSE	TROUBLESHOOTING
Irreversible clouding of glassware.	Glasses are not dishwasher-proof, only suitable for dishwashers.	<ul style="list-style-type: none"> Use dishwasher-proof glasses. Glasses are usually only suitable for use in a dishwasher, i.e. long-term wear or long-term changes must be expected. Avoid a lengthy steam phase (standing time after wash cycle ends). Use a programme with a lower temperature. → "Overview of programmes", Page 14 Set the softening system to the water hardness. → "Setting the water softening system", Page 18 Use detergent with a glass protection component.
Rust spots on cutlery.	Cutlery is not sufficiently rust-resistant. Knife blades are often more severely affected.	<ul style="list-style-type: none"> Use rust-resistant tableware.
	Cutlery may also rust if washed together with rusting items.	<ul style="list-style-type: none"> Do not wash rusting items.
	Salt content in washing water is too high.	<ol style="list-style-type: none"> Remove any spilled special salt from the tub. Screw the cap of the special salt dispenser on tight.
Detergent residue is present in the detergent dispenser or the tablet collecting tray.	Spray arms were blocked by tableware so detergent was not rinsed out.	<ul style="list-style-type: none"> Check that the spray arms are not blocked and can rotate freely.
	Detergent dispenser was damp when detergent was added.	<ul style="list-style-type: none"> Only add detergent to a detergent dispenser when dry.
Excessive formation of foam occurs.	Hand washing-up liquid is present in dispenser for rinse aid.	<ul style="list-style-type: none"> Immediately add rinse aid to the dispenser. → "Adding rinse aid", Page 19
	Rinse aid has been spilled.	<ul style="list-style-type: none"> Remove the rinse aid with a cloth.
	Detergent or appliance care product used causes excessive foaming.	<ul style="list-style-type: none"> Change the brand of detergent.

Information on display panel

FAULT	CAUSE	TROUBLESHOOTING
Special salt refill indicator lights up.	Insufficient special salt.	<ul style="list-style-type: none"> Add "Special salt" → Page 19.
	Sensor does not detect special salt tablets.	<ul style="list-style-type: none"> Do not use special salt tablets.
Refill indicator for special salt does not light up.	Water softening system is switched off.	<ul style="list-style-type: none"> Set the water softening system. → "Setting the water softening system", Page 18
Refill indicator for rinse aid lights up.	Insufficient rinse aid.	<ol style="list-style-type: none"> Add "Rinse aid" → Page 19. Set the amount of rinse aid to be dispensed. → "Setting the amount of rinse aid", Page 20
Refill indicator for rinse aid does not light up.	Rinse aid system is switched off.	<ul style="list-style-type: none"> Set the amount of rinse aid to be dispensed. → "Setting the amount of rinse aid", Page 20

Malfunctions

FAULT	CAUSE	TROUBLESHOOTING
Water is left in the appliance at the end of the programme.	Filter system or area under the filters is blocked.	<ol style="list-style-type: none"> Clean the "Filters" → Page 26. Clean the "Wastewater pump" → Page 36.
	Programme has not yet ended.	<ul style="list-style-type: none"> Wait until the programme ends or cancel the programme with Reset. → "Terminate programme", Page 23

FAULT	CAUSE	TROUBLESHOOTING
Appliance cannot be switched on or operated.	Appliance functions have failed.	<ol style="list-style-type: none"> 1. Pull out the mains plug or switch off the fuse. 2. Wait at least 2 minutes. 3. Connect the appliance to the power supply. 4. Switch the appliance on.
Appliance does not start.	The mains fuse has tripped.	<ul style="list-style-type: none"> • Check the relevant fuse.
	Mains cable is not inserted.	<ol style="list-style-type: none"> 1. Check whether the socket works. 2. Check whether the mains cable is properly inserted in the socket and on the rear of the appliance.
	Appliance door is not closed properly.	<ul style="list-style-type: none"> • Close the appliance door.
Programme starts automatically.	You did not wait until programme ended.	<ul style="list-style-type: none"> • → "Terminate programme", Page 23
Appliance stops during the programme or cuts out.	Appliance door is not closed properly.	<ul style="list-style-type: none"> • Close the appliance door.
	Power and/or water supply has been interrupted.	<ol style="list-style-type: none"> 1. Check the power supply. 2. Check the water supply.
	Top basket is pressing against inner door and preventing appliance door from being closed securely.	<ul style="list-style-type: none"> • Check whether the rear panel of the appliance is being pressed in by a socket or hose holder that has not been removed. • Arrange the tableware so that no parts project beyond the basket and prevent the appliance door from closing properly.
All LEDs lit up or flashing.	Electronics have detected a fault.	<ol style="list-style-type: none"> 1. Press the main switch button for approx. 4 seconds. The appliance is reset and restarted. 2. If the problem occurs again: <ul style="list-style-type: none"> • Switch off the appliance. • Pull out the mains plug or switch off the fuse in the fuse box. • Wait at least 2 minutes. • Switch on the fuse in the fuse box or insert the mains plug. • Switch the appliance on. 3. If the problem occurs again: <ul style="list-style-type: none"> • Contact customer service.

Mechanical damage

FAULT	CAUSE	TROUBLESHOOTING
Appliance door cannot be closed.	Door lock has been activated.	<ul style="list-style-type: none"> • Close the appliance door with greater force.
	Door cannot be closed due to installation method.	<ul style="list-style-type: none"> • Check whether the appliance has been installed properly. <p>When closed, the appliance door, its decor or attached parts should not knock against adjacent cabinets or the worktop.</p>
Lid on the detergent dispenser cannot be closed.	Detergent dispenser or lid are blocked by sticky detergent residue.	<ul style="list-style-type: none"> • Remove detergent residue.

Noise

FAULT	CAUSE	TROUBLESHOOTING
Filling valves making knocking noises.	Caused by the domestic installation. No appliance fault present. Does not affect functioning of the appliance.	<ul style="list-style-type: none"> • Can only be remedied in the domestic installation.

FAULT	CAUSE	TROUBLESHOOTING
Knocking or rattling noise.	Spray arm is striking tableware.	<ul style="list-style-type: none">• Arrange tableware so that the spray arms do not strike tableware.
	With a small load the water jets directly strike against the tub.	<ul style="list-style-type: none">• Distribute the tableware evenly.• Load the appliance with more tableware.
	Light items of tableware move about during the wash cycle.	<ul style="list-style-type: none">• Position light items of tableware securely.

Clean wastewater pump

Large remnants of food or foreign bodies can block the waste water pump. As soon as the rinsing water no longer drains properly, the waste water pump must be cleaned.

WARNING Risk of injury!

- Sharp and pointed objects or fragments of glass may block the waste water pump and cause injury.
- Remove any foreign bodies carefully.

1. Disconnect the appliance from the power supply.
2. Remove the top and bottom basket.
3. Remove the filter system.
4. Scoop out any water.
Use a sponge if necessary.
5. Prise off the pump cover using a spoon and grip it by the crosspiece.

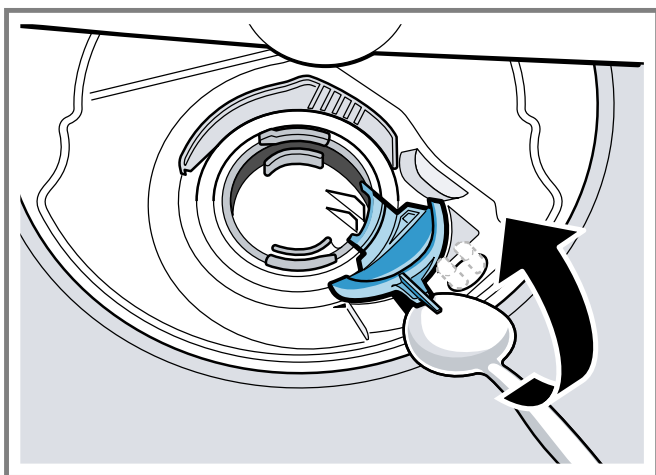

6. Lift the pump cover inwards at an angle and remove.
 - ✓ You can now reach the impeller with your hand.
7. Remove any remnants of food and foreign bodies in the area of the impeller.
8. Insert the pump cover ① and press down ②.

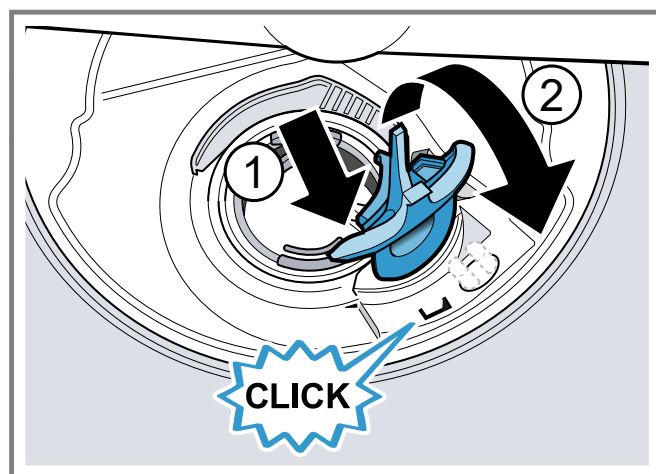

- ✓ The pump cover clicks into position.
9. Install the filter system.
 10. Insert the top and bottom basket.

Transportation, storage and disposal

Removing the appliance

1. Disconnect the appliance from the mains power supply.
2. Turn off the water tap.
3. Detach the drainage connection.
4. Detach the drinking water connection.
5. Loosen any screws fastening the appliance to cabinet parts.
6. Remove the base panel if fitted.
7. Pull the appliance out carefully, along with the hose behind it.

Protect appliance from frost

If there is a risk of frost where the appliance will be standing, e.g. in a holiday home, empty the appliance completely.

- Empty the appliance.
→ "Transporting the appliance", Page 36

Transporting the appliance

To avoid damage to the appliance, empty it before transporting.

Note: Always transport the dishwasher upright to prevent residual water getting into the machine's controls and damaging the appliance.

1. Remove tableware from the appliance.
2. Secure loose parts.
3. "Switch on the appliance." → Page 23
4. Select the programme with the highest temperature.
→ "Overview of programmes", Page 14
5. "Start the programme." → Page 23
6. To drain the appliance, terminate the programme after approx. 4 minutes.
→ "Terminate programme", Page 23
7. "Switch off the appliance." → Page 23
8. Turn off the water tap.
9. To empty the residual water out of the appliance, detach the supply hose and let the water drain out.

Disposing of old appliance

Valuable raw materials can be reused by recycling.

WARNING

Risk of harm to health!

- Children can lock themselves in the appliance, thereby putting their lives at risk.
- With redundant appliances, unplug the power cord. Then cut through the cord and damage the lock on the appliance door beyond repair so that the appliance door will no longer close.

1. Unplug the appliance from the mains.

2. Cut through the power cord.
3. Dispose of the appliance in an environmentally friendly manner.

Information about current disposal methods are available from your specialist dealer or local authority.



This appliance is labelled in accordance with European Directive 2012/19/EU concerning used electrical and electronic appliances (waste electrical and electronic equipment - WEEE). The guideline determines the framework for the return and recycling of used appliances as applicable throughout the EU.

Technical specifications

Weight	Max.: 60 kg
Voltage	220 - 240 V, 50 Hz or 60 Hz
Power rating	2000 - 2400 W
Fuse	10 - 16 A
Water pressure	<ul style="list-style-type: none"> • Min. 0.05 MPa (0.5 bar) • Max. 1 MPa (10 bar)
Inlet rate	Min. 10 l/min
Water temperature	Cold water. Hot water max.: 60 °C
Capacity	14 place settings

More information about your model can be found online at <https://eprel.ec.europa.eu/qr/1391315>¹. This web address is linked to the official EU EPREL product database.

Information regarding free and open source software

This product includes software components that are licensed by the copyright holders as free or open source software.

This licence information can be downloaded via our home page www.ikea.com. Alternatively, you can request relevant information from se.hfb70.running.range@inter.ikea.com. The source code will be made available to you on request. Please send your request to the above address. Subject: "FOSS"

Declaration of Conformity

IKEA of Sweden AB hereby declares that the appliance conforms to the essential requirements and other relevant provisions of Directive 2014/53/EU.

A detailed RED Declaration of Conformity can be found online at www.ikea.com among the additional documents on the product page for your appliance.



Hereby, IKEA of Sweden AB declares that the appliance is in compliance with relevant statutory requirements.²

A detailed Declaration of Conformity can be found online at www.ikea.com among the additional documents on the product page for your appliance.²



2.4 GHz band (2400–2483.5 MHz): Max. 100 mW
5-GHz band (5150–5350 MHz + 5470–5725 MHz): max. 150 mW

	BE	BG	CZ	DK	DE	EE	IE	EL	ES
	FR	HR	IT	CY	LI	LV	LT	LU	HU
	MT	NL	AT	PL	PT	RO	SI	SK	FI
	SE	NO	CH	TR	IS	UK (NI)			

5 GHz WLAN (Wi-Fi): For indoor use only.

AL	BA	MD	ME	MK	RS	UK	UA
----	----	----	----	----	----	----	----

5 GHz WLAN (Wi-Fi): For indoor use only.

¹ Only applies to countries in the European Economic Area

² Only applies to Great Britain

IKEA guarantee

FAQs about the warranty:

How long is the IKEA warranty valid?

This warranty is valid for five (5) years from the original date of purchase of your appliance at IKEA. The original sales receipt, is required as proof of purchase. If service work is carried out under warranty, this will not extend the warranty period for the appliance.

Who will execute the service?

IKEA service provider will provide the service through its own service operations or authorised service partner network.

What does this warranty cover?

This warranty only applies to domestic use of the relevant product. The exceptions are specified under the headline "What is not covered under this warranty?" Within the warranty period, the costs to remedy the fault e.g. repairs, spare parts, labour and travel will be covered, provided that the appliance is accessible for repair without special expenditure. The respective local regulations are applicable. Replaced parts become the property of IKEA.

What will IKEA do to correct the problem?

The IKEA-appointed service provider will examine the product and decide, at its sole discretion, if it is covered under this warranty. If considered covered, the IKEA-appointed service provider or its authorised service partner through its own service operations will then, at its sole discretion, either repair the defective product or replace it with the same or a comparable product.

What is not covered under this warranty?

- Normal wear and tear.
- Deliberate or negligent damage, damage caused by failure to observe the user manual, incorrect installation or by connection to the wrong voltage, damage caused by chemical or electrochemical reaction, rust, corrosion or water damage including but not limited to water damage caused by excessive lime in the water supply, and damage caused by abnormal environmental conditions.
- Consumable parts including batteries and bulbs.
- Non-functional and decorative parts which do not affect normal use of the appliance, including any scratches and possible differences in colour.
- Accidental damage caused by foreign objects or substances and damage associated with cleaning or unblocking of filters, drainage systems or soap drawers.
- Damage to the following parts: ceramic glass, accessories, crockery and cutlery baskets, inlet and outlet hoses, seals, lamps and lamp covers, displays, knobs, panels, housing covers and parts of housings. Unless such damage can be proved to have been caused by production faults.
- Cases where no damage could be found during a technician's visit.
- Repairs not carried out by our appointed service providers and/or an authorised contractual service partner, or where non-original spare parts have been used.
- Repairs caused by installation which was improper or not according to specification.
- Use of the appliance in a non-domestic environment, i.e. professional use.
- Transport damage: Where the product is transported by customers themselves either to their home or to another address, IKEA shall not be liable for any damage which

may occur during such transport. However, if IKEA delivers the product to the customer's delivery address, then damage to the product that occurs during this delivery will be covered by IKEA .

- Cost of carrying out initial installation of the IKEA appliance. However, if an IKEA-appointed service provider or its authorised service partner repairs or replaces the appliance under the terms of this warranty, the appointed service provider or its authorised service partner will reinstall the repaired appliance or install the replacement, if necessary.

How country law applies

The IKEA warranty gives you specific legal rights, which cover or exceed all the local legal demands. However these conditions do not limit in any way consumer rights described in the local legislation.

Scope of applicability

For appliances which are purchased in one EU country and taken to another EU country, the services will be provided in the framework of the warranty conditions normal in the new country. An obligation to carry out services under the warranty exists only if the appliance complies and is installed in accordance with:

- the technical specifications of the country in which the warranty claim is made;
- the installation instructions and safety information in the user manual.

Customer Service for IKEA appliances

Please don't hesitate to contact the IKEA-appointed authorised service centre:

- to make a service request under this warranty;
- to ask for clarification about functions of IKEA appliances.

To ensure that we provide you with the best assistance, please read the installation instructions and/or the user manual before contacting us.

How to reach us if you need our service



On the final page of this user manual you will find a full list of authorised service centres selected by IKEA, together with the relevant national telephone numbers.

To provide you with faster service, please use the telephone numbers listed in this user manual.

When calling us, make sure that you have the details of the relevant appliance to hand. These are:

- Appliance number (E-Nr = 1)
- Production number (FD = 2)
- IKEA article number (8 digit code located on the line below the appliance number (E-Nr))
- IKEA manufacturing date (located on the care label on the side of the inner door)

This information can be found on the "rating plate"
→ Page 11 on the appliance door.

SAVE THE SALES RECEIPT!

Note: It is your proof of purchase and required for the warranty to apply. The sales receipt also shows the IKEA designation and article number (8-digit code) for each of the appliances you have purchased.

Do you need extra help?

For any further questions not related to customer service for your appliance, please contact the hotline of your nearest IKEA store. Before contacting us, please read the appliance documentation carefully.

After-sales service

You can find an overview of the telephone numbers for customer service and information on spare parts availability at the end of this document.

Function-relevant genuine spare parts according to the corresponding Ecodesign Order can be obtained from Customer Service for a period of at least 10 years from the date on which your appliance was placed on the market within the European Economic Area.

Availability of spare parts:

Door hinges and door seals, other seals, spray arms, strainer filters, inner support and plastic accessories, such as baskets and lid. As well as other spare parts, e.g. cutlery drawers, handles, inserts, holders, fixing sets, insulating plates, locks, child-proof door locks, rails, housing side parts, Aquastop, cable connections, Aquastop valves, hinge belts, bearings, power cords, protective covers, rubber forming parts, ventilation ducts, water storage tanks, actuators, hoses, hose clamps, display modules, panel boxes, handle strips, perspex doors, sump seals, basket rollers, clamps, cutlery baskets, clamps, fixing parts, cup racks, heat exchangers, threaded screws, flow-through sensors, drain hoses, water softening systems, regeneration valves, pump sumps, screws, water switches, heating pumps, drain pumps, pipes, upper and lower spray arms, fine filters, micro filters, dosing containers, doors and much more...

Service Contacts

Country	Phone number	Call Fee	Opening time
Australia	1300008610	Local tariff	Monday - Friday 8.00 - 24.00
België / Belgique / Belgien	024757120	Lokaal tarief / Prix d'un appel local / Ortstarif	Maandag - Vrijdag / Lundi - Vendredi / Montag - Freitag 8.00 - 17.00
България	070020818	в зависимост от тарифния план на клиента	Понеделник - Събота 8.00 - 20.00 часа
Česká republika	+420251095027	Závisí na tarifu lokálního operátora	Po - Čt 8.30 - 18.00 Pá 8.30 - 17.00
Danmark	70150909	Lokal takst	Mandag - fredag 9.00 - 20.00 Lørdag (Åbent udvalgte søndage, se IKEA.dk) 9.00 - 18.00
Deutschland	08912475328	Ortstarif	7 Tage die Woche 7.00 - 22.00
Ελλάδα	+302104277770	Τυπική αστική χρέωση	24 ώρες, 7 ημέρες την εβδομάδα
España	976 305740	llamada local	Lunes - Viernes 7.00 - 22.00 Sábado 7.00 - 15.00
France	0969327707	appel non surtaxé	lundi - dimanche 7.00 - 22.00
Hrvatska	01/5520-337	Cijena lokalnog poziva ovisno o tarifi i paketu vašeg pružatelja usluge	svaki dan od 00 - 24h
Ireland	014502655	Local tariff	Monday - Friday 8.00 - 20.00 Saturday 9.00 - 17.00 Sunday 9.00 - 16.00
Ísland	+3544312200	Venjulegur símakostnaður	Mánudagur - Föstudagur 10.00 - 17.00
Italia	02412678501	Tariffa locale	Lunedì - Venerdì 8.00 - 20.00 Sabato 8.00 - 13.00
Lietuva	+370852463350	Vietinių pokalbių įkainiai	Pirmadienis - Penktadienis 9.00 - 17.00
Luxemburg / Luxembourg	26349-861	Ortstarif aus Luxembourg / Prix d'un appel local depuis le Luxembourg	Montag - Freitag / Lundi - Vendredi 8.00 - 12.00 ; 13.00 - 17.00
Magyarország	0680200201	Díjmentes telefonszám	Hívható munkanapokon 8.00 - 17.00
Nederland	09002354532 en/of 0900 BEL IKEA	15 cent/min., starttarief 4.54 cent en gebruikelijke belkosten	Maandag t/m - Vrijdag 8.00 - 20.00 Zaterdag 9.00 - 20.00
Norge	22660560	Lokal takst	Mandag - Fredag 8.00 - 21.00 Lørdag - Søndag 9.00 - 16.00
Österreich	0810144180	Ortstarif	7 Tage die Woche 7.00 - 22.00
Polska	801002068	Jak za połączenie lokalne lub według stawek operatora sieci komórkowej	Poniedziałek - Niedziela w godzinach 7.00 - 22.00
Portugal	214250784	custo de chamada para número fixo	segunda a sexta 8.30 - 20.00 sábado 9.00 - 18.00
România	+40212039748	Tarif normal	Lu-Vi: 8.00 - 20.00 Sam. 9.00 - 16.00
Россия	88002003040	бесплатно по России с любых номеров	круглосуточно 24/7
Schweiz / Suisse / Svizzera	0848808555	max. 0.075 CHF / min. + MwSt./TVA./IVA./VAT.	Montag - Freitag / Lundi - Vendredi / Lunedì - Venerdì 8.00 - 17.00
Suomi	08207510790	Paikallinen tariffi, matkapuhelin 8,35 senttiä puhelua kohti + 16,69 senttiä min	Maanantaista-torstaihin 8.00 - 17.00 Perjantaihin 9.00 - 16.00
Sverige	0775700500	Lokal samtal	Måndag - Fredag 8.30 - 20.00 Lördag - Söndag 9.30 - 18.00
United Kingdom	03301343106	Local tariff	Monday - Friday 8.00 - 20.00 Saturday 9.00 - 17.00 Sunday 9.00 - 16.00
Србија	+381113537009	Cijene lokalnog poziva ovisno o tarifama i paketu vašeg pružatelja usluga	Pon-Sub: 8.00 - 20.00
Slovenská republika	+420251095028	Závisí na tarife lokálneho operátora	Po - Št 8.30 - 18.00 Pia 8.30 - 17.00
Slovenija	+386 1 5830 701	Lokalna tarifa	Pon. - Sob. ; 7:00- 20:00
Latvija	www.ikea.com	-	-
Україна	www.ikea.com	-	-
Eesti	www.ikea.com	-	-



A series of horizontal lines for writing, starting below a grey header bar and extending to the bottom of the page. The lines are evenly spaced and cover the majority of the page's width.



A series of horizontal lines for writing, consisting of 25 evenly spaced lines extending across the width of the page.



9001775006 (040410) 650 A5

