

MUTEBO

da nl
en fi
fr de
el is
it no
pt es
sv



Design and Quality
IKEA of Sweden

DANSK	7
NEDERLANDS	12
ENGLISH	17
SUOMI	22
FRANÇAIS	27
DEUTSCH	32
ΕΛΛΗΝΙΚΑ	37
ÍSLENSKA	42
ITALIANO	47
NORSK	52
PORTUGUÊS	57
ESPAÑOL	62
SVENSKA	67

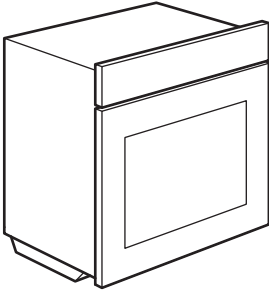
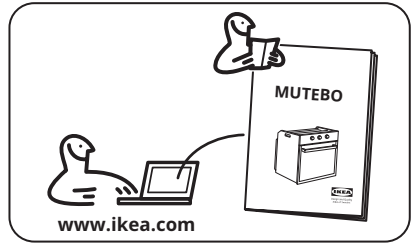
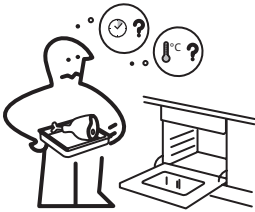

1x

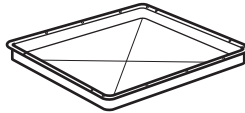

1x



1x

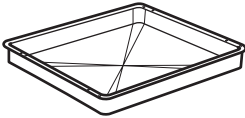

1x

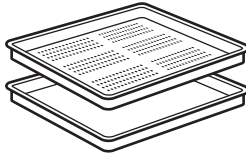

1x



1x

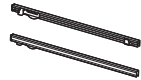

1x

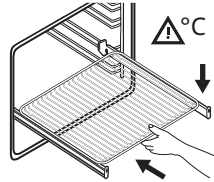
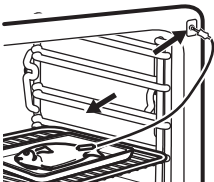
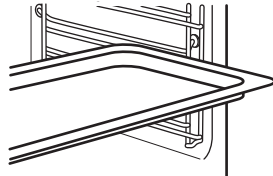
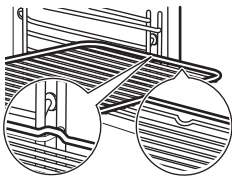

START



MAX

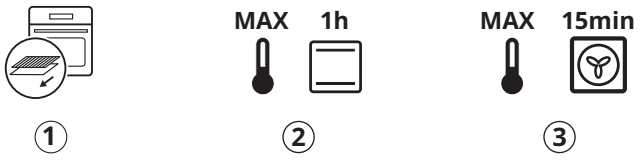

1 sec



MAX 23 h 59 min

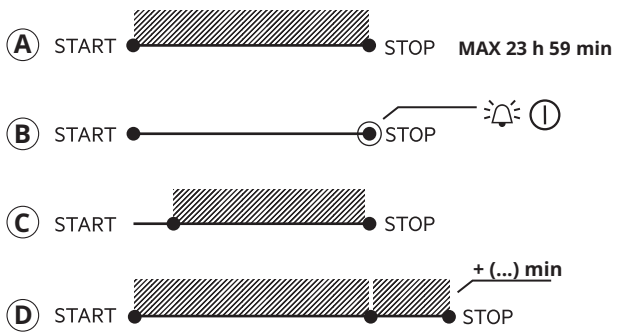

E 06:59 06:58 06:57 ... 00:00 [bell icon]

F 00:00 00:01 00:02 ...

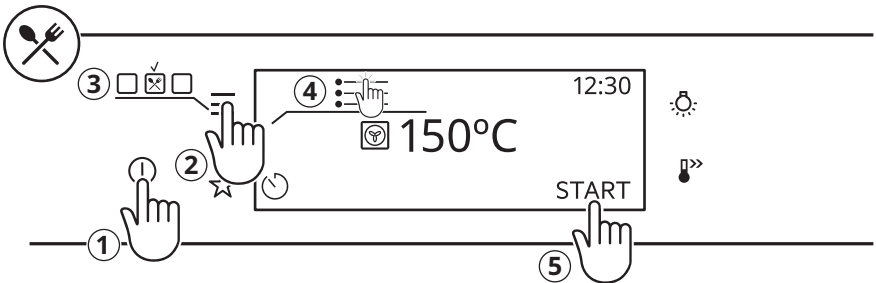
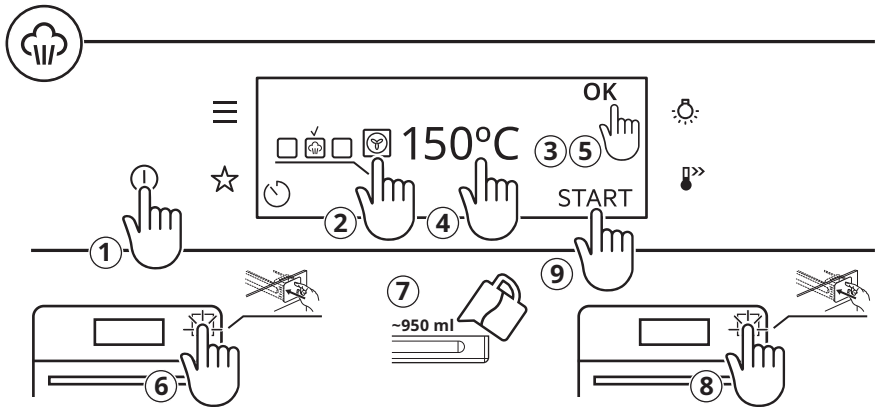
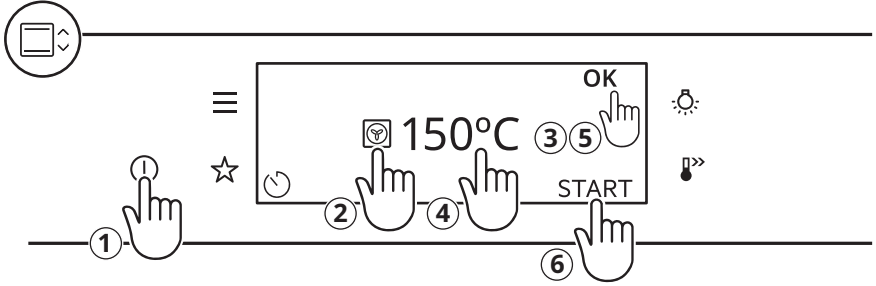

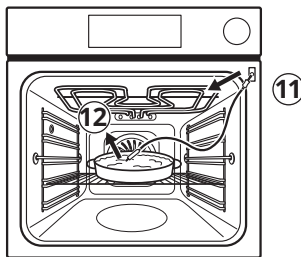
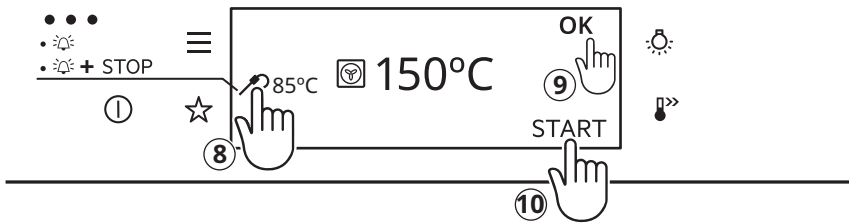
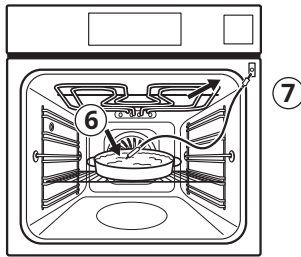
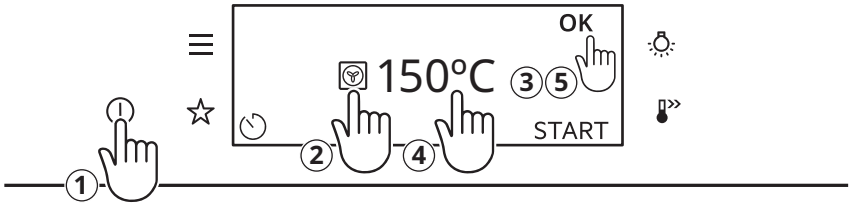

Produktbeskrivelse

Generelt overblik

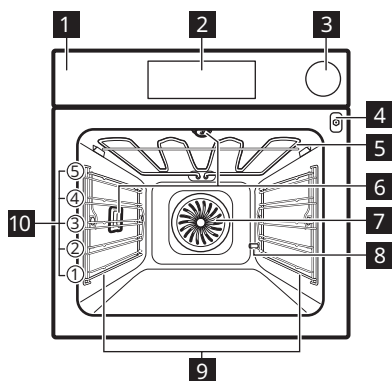

- 1** Betjeningspanel
- 2** Skærm
- 3** Vandbeholder
- 4** Stik til termometer
- 5** Varmelegeme
- 6** Ovnperæ
- 7** Blæser
- 8** Afkalkning af afløbsrøret
- 9** Ovnribbe, udtagelig
- 10** Ovnriiler

Betjeningspanel

Oversigt over betjeningspanel

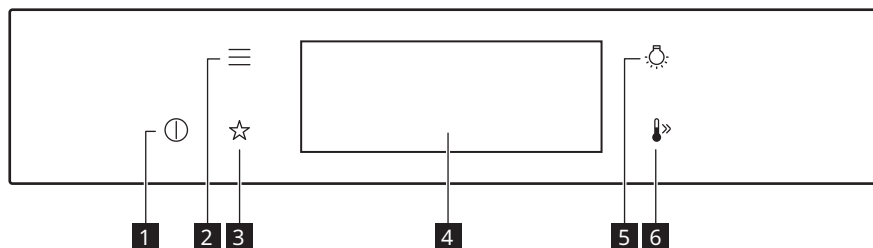

1	TIL / FRA	Tryk og hold nede for at tænde og slukke apparatet.
2	Menu	Angiver apparatets funktioner.
3	Favoritter	Angiver favoritindstillingerne.
4	Skærm	Viser apparatets aktuelle indstillinger.

5	Lampeafbryder	Til at tænde og slukke lampen.
6	Hurtig opvarmning	Til at tænde og slukke funktionen: Hurtig opvarmning.

Displaylamper

Display med vigtige funktioner.

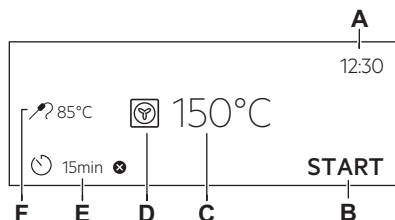

- A. Aktuell tid
- B. START/STOP
- C. Temperatur
- D. Ovnfunktioner
- E. Timer
- F. Termometer (kun udvalgte modeller)

Grundlæggende lamper - til navigation på displayet.

	For at bekræfte valget/indstillingen.
	For at gå ét niveau tilbage i menuen.
	For at fortryde den sidste handling.
	For at slå tilvalgte til og fra.

Akustisk alarm funktionslamper - når den indstillede tilberedningstid er slut, høres signalet.

	Funktionen er tændt.
	Funktionen er tændt. Tilberedningen stopper automatisk.
	Den akustiske alarm slukkes.
	For at indstille funktionen: Udskudt start.
	For at annullere indstillingen.

Daglig brug

Ovnfunktioner

STANDARD

	Varmluft: Jævn bagning, mørt kød, tørring
	Over-/undervarme: Traditionel bagning
	Frosne madvarer: Pommes frites, kartoffelbåde, forårsruller
	Pizza: Pizza-bagning
	Undervarme: Bagning af kager
	Grillstegning: Stegning, grillstegning
	Turbogrill: Stegning af kød, bruning

Varmluft, Over-/undervarme: Når du indstiller temperaturen til under 80°C, slukkes lampen automatisk efter 30 sekunder.

SPECIALPROGRAMMER

	Henkogning: Henkogning af grøntsager
--	---

	Tørring: Tørring af skåret frugt, champignoner
	Tallerkenvarmer: Forvarmingsplader
	Optøning: Optøning
	Gratiner: Lav gratiner, bruning
	Lavtemperaturstegning: Tilberedning af mør steg
	Holde varm: Hold maden varm
	Fugtig varmluft: Bagning

DAMP

	Easystem: Dampning, stuvning, let sprød skorpe, bagning, stegning
	Opvarmning med damp: Opvarmning på en tallerken
	Brød: Brød, småt gærbrød
	Hævning af dej: Hævning af gærdej

	Fuld damp: Grøntsager, tilbehør, fisk
	Fugtighed høj: Kager, tærter, terriner, fisk
	Fugtighed lav: Kød, fjerkræ, ovnretter, gryderetter

Bemærkninger til: Fugtig varmluft

Denne funktion blev anvendt til at overholde kravene i energieffektivitetsklasse og økodesign (i overensstemmelse med EU 65/2014 og EU 66/2014). Tests i overensstemmelse med:

IEC/EN 60350-1

Ovnlågen skal være lukket under tilberedningen, så funktionen ikke afbrydes, og ovnen kører med den højeste energieffektivitet, der er mulig.





Når du bruger denne funktion, slukkes lampen automatisk efter 30 sekunder.

Denne funktion er beregnet til at spare energi under madlavning. Når du bruger

denne funktion, kan temperaturen i ovnrummet variere fra den indstillede temperatur. Varmeeffekten kan blive reduceret.

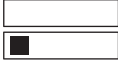
Vandets hårdhed

Du kan ændre vandets hårdhedsgrad i menuen: Indstillinger / Opsætning / Vandets hårdhed.

Vandets hårdhedsgrad	Testpapir
1 - blød	
2 - moderat hårdt	
3 - hårdt	
4 - meget hårdt 1)	

1) Når vandets hårdhedsgrad er 4, skal du fylde vandbeholderen med flaskevand.

Fejlfinding

Hvis du støder på et problem med dit apparat, kan du se kapitlet "Fejlfinding" i den

fulde version af brugervejledningen, som findes på: www.ikea.com.

Produktoplysninger og produktinformationsark

Leverandørens navn	IKEA
Identifikation af model	MUTEBO 105.570.41
Energieffektivitetsindeks	61.9
Energieffektivitetsklasse	A++
Energiforbrug med en standardmængde, almindelig tilstand	1.09 kWh/cyklus
Energiforbrug med en standardmængde, blæsertungen tilstand	0.52 kWh/cyklus
Antal ovnrum	1
Varmekilde	Elektricitet
Volumen	70 l
Type ovn	Indbygningsovn
Vægt	35.5 kg
IEC/EN 60350-1 - Elektriske husholdningsapparater til madlavning - Del 1: Komfurer, ovne, dampovne og grillapparater - Metoder til måling af ydeevne.	

Menustruktur

Menu

Menupunkt		Applikation
Hjælp til tilberedning		Angiver automatiske programmer.
Rengøring		Angiver rengøringsprogrammer.
Favoritter		Angiver favoritindstillingerne.
Tilvalg		For at indstille ovnkonfigurationen.
Indstillinger	Opsætning	For at indstille ovnkonfigurationen.
	Service	Viser softwarens version og konfiguration.

Undermenu for: Rengøring

Undermenu	Applikation
Tørring	Tørring af ovnrummet for kondensvand efter brug af dampfunktionerne.
Tømning af vandbeholder	Fremgangsmåde for at fjerne restvandet fra vandbeholderen efter brug af dampfunktionerne.
Rengøring med damp	Let rengøring.
Rengøring med damp plus	Grundig rengøring.
Afkalkning	Rengøring af dampkredsløbet for kalk.
Rensning af dampgenerator	Procedure til rensning og rengøring af dampkredsløbet efter hyppig brug af dampfunktionerne.

Undermenu for: Tilvalg

Undermenu	Applikation
Lys	Slår lampen til og fra.
Børnesikring	Forhindrer utilsigtet aktivering af ovnen. Når tilvalget er slået til, vises teksten Børnesikring i displayet, når du tænder for apparatet. For at aktivere brugen af ovnen skal du vælge kodebogstaverne i alfabetisk rækkefølge. Adgang til timeren, fjernbetjent tilstand og pæren er mulig med tilvalget slået til.
Hurtig opvarmning	Afkorter opvarmningstiden. Den er kun tilgængelig for nogle af ovnens funktioner.
Husk rengøring	Slår påmindelsen til og fra.
Tidsangivelse	Slår uret til og fra.
Digitalt ur	Ændrer formatet på den viste tid.

Undermenu for: Opsætning

Undermenu	Beskrivelse
Sprog	Indstiller ovnens sprog.
Lysstyrke display	Indstiller displayets lysstyrke
Panelsignal	Aktiverer og deaktiverer tonen i berøringsfelterne. Lydsignalet kan ikke slås fra for: ①.
Signal volume	Indstiller lydstyrken af tastetoner og signaler.
Vandets hårdhed	Indstiller vandets hårdhed.
Aktuel tid	Indstiller den aktuelle tid og dato.

Undermenu for: Service

Undermenu	Beskrivelse
Demo funktion	Aktiverings- / deaktiveringskode: 2468
Softwareversion	Oplysninger om softwareversion.
Nulstil alle indstillinger	Gendanner fabriksindstillingerne.

Beschrijving van het product

Algemeen overzicht

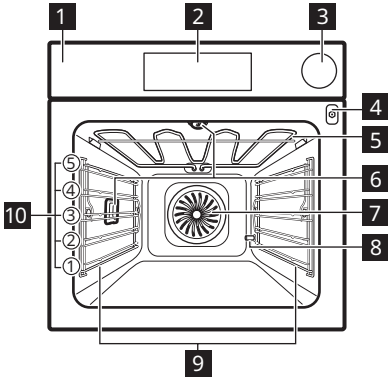

- 1** Bedieningspaneel
- 2** Display
- 3** Waterreservoir
- 4** Opening voor de voedsensor
- 5** Verwarmingselement
- 6** Lamp
- 7** Ventilator
- 8** Uitgang ontkalkingsleiding
- 9** Inschui rails, verwijderbaar
- 10** Inzetniveaus

Bedieningspaneel

Overzicht bedieningspaneel

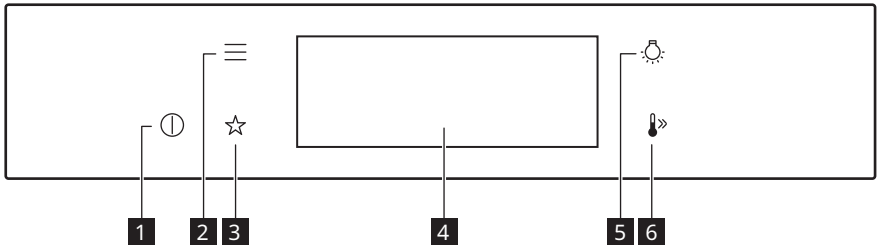

1	Aan / UIT	Houd ingedrukt om het apparaat in en uit te schakelen.
2	Menu	Vermeldt de functies van het apparaat.
3	Favorieten	Geeft een overzicht van de favoriete instellingen.
4	Display	Geeft de huidige instellingen van het apparaat weer.

5	Lampschakelaar	Om de verlichting in en uit te schakelen.
6	Snel opwarmen	Om de functie in en uit te schakelen: Snel opwarmen.

Indicatielampjes op de display

Display met toetsfuncties.

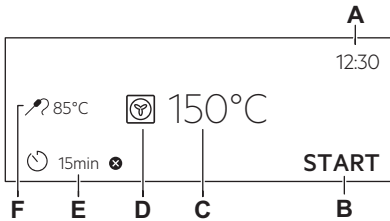

- A. Dagtijd
- B. BEGIN/STOP
- C. Temperatuur
- D. Verwarmingsfuncties
- E. Timer
- F. Voedselsensor (alleen geselecteerde modellen)

Basisindicatielampjes: om op de display te navigeren.

	Om de selectie/instelling te bevestigen.
	Om één niveau terug te gaan in het menu.
	Om de laatste handeling ongedaan te maken.
	Om de opties in en uit te schakelen.

Geluidsalarm functie-indicatielampjes: wanneer de ingestelde kooktijd ten einde is, klinkt het signaal.

	De functie is ingeschakeld.
	De functie is ingeschakeld. Het koken stopt automatisch.
	Het geluidsalarm staat uit.
	De functie instellen: Uitgestelde start.
	Om de instelling te annuleren.

Dagelijks gebruik

Verwarmingsfuncties

STANDAARD

	Hetelucht: Zelfs bakken, malsheid, drogen
	Boven + onderwarmte: Traditioneel bakken
	Bevroren gerechten: Patat, aardappelpartjes, lentebroodjes
	Pizza-functie: Pizza bakken
	Onderwarmte: Baktaarten
	Grillen: Roosteren, grillen
	Circulatiegrill: Braadvlees, bruining

Hetelucht, Boven + onderwarmte: Als u de temperatuur instelt onder 80°C, gaat de lamp na 30 seconden automatisch uit.

SPECIAAL

	Inmaken: Groenten bewaren
--	----------------------------------

	Drogen: Gesneden fruit, champignons drogen
	Borden warmen: Voorverwarmen van platen
	Ontdooien: Ontdooien
	Gratineren: Gegratineerd maken, bruinen
	Lage temperatuur garen: Bereiden van mals gebraad
	Warm houden: Voedsel warm houden
	Warmelucht (vochtig): Bakken

STOOM

	Easystem: Stoomen, stoven, zacht krokant maken, bakken, braden
	Regenereren: Opnieuw opwarmen op een bord
	Brood bakken: Brood, broodjes
	Deeg laten rijzen: Het laten rijzen van gistdeeg

	Stoom: Groenten, bijgerechten, vis
	Hoge vochtigheid: Custards, vlaaien, terrines, vis
	Lage vochtigheid: Vlees, gevogelte, ovengerechten, stoofschotels

Notities over: Warmelucht (vochtig)

Deze functie wordt gebruikt om te voldoen aan de energie-efficiëntieklasse en ecodesign-vereisten (overeenkomstig EU 65/2014 en EU 66/2014). Testen in overeenstemming met:

IEC/EN 60350-1

De ovendeur dient tijdens de bereiding gesloten te zijn zodat de functie niet wordt onderbroken en de oven werkt op de hoogst mogelijke energie-efficiëntie.





Bij gebruik van deze functie gaat de verlichting na 30 seconden automatisch uit.

Deze functie is ontworpen om tijdens de bereiding energie te besparen. Bij het

gebruik van deze functie kan de temperatuur in de ruimte verschillen van de ingestelde temperatuur. Het verwarmingsvermogen kan worden verminderd.

Waterhardheid

U kunt het waterhardheidsniveau wijzigen in het menu: Instellingen / Instelling / Waterhardheid.

Waterhardheidsniveau	Testpapier
1 - zacht	
2 - matig hard	
3 - hard	
4 - heel hard¹⁾	

1) Als het kraanwaterhardheidsniveau 4 is, vult u de waterlade met plat flessenwater.

Probleemoplossing

Als u op een probleem met uw apparaat stuit, raadpleeg dan het hoofdstuk "Probleemoplossing" in de volledige versie

van de gebruikershandleiding, beschikbaar op: www.ikea.com.

Productinformatie en productinformatieblad

Naam leverancier	IKEA
Modelnummer	MUTEBO 105.570.41
Energie-efficiëntie-index	61,9
Energie-efficiëntieklasse	A++
Energieverbruik met een standaard belading, conventionele modus	1,09 kWh/cyclus
Energieverbruik met een standaard belasting, heteluchtmodus	0,52 kWh/cyclus
Aantal holtes	1
Warmtebron	Elektriciteit
Volume	70 l
Soort oven	Inbouwoven
Massa	35,5 kg
IEC/EN 60350-1 - Huishoudelijke elektrische kooktoestellen - Deel 1: Fornuizen, ovens, stoomovens en grills - Methoden voor het meten van prestaties.	

Menustructuur

Menu

Menu-item		Toepassing
Kook- En Bakassistent		Toont overzicht van de automatische programma's.
Reinigen		Toont overzicht van de schoonmaakprogramma's.
Favorieten		Geeft een overzicht van de favoriete instellingen.
Opties		Om de apparaatconfiguratie in te stellen.
Instellingen	Instelling	Om de apparaatconfiguratie in te stellen.
	Service	Toont de softwareversie en -configuratie.

Submenu voor: Reinigen

Submenu	Toepassing
Drogen	Procedure om de resterende condensatie in de holte op te laten drogen na gebruik van de stoomfuncties.
Reservoir ledigen	Procedure voor het verwijderen van het restwater van de waterlade na gebruik van de stoomfuncties.
Stoomreiniging	Licht reinigen.
Stoomreiniging Plus	Grondig reinigen.
Ontkalken	Verwijderen van kalkresten uit de stoomgenerator.
Spoelen	Procedure voor het spoelen en reinigen van de stoomgenerator na frequent gebruik van de stoomfuncties.

Submenu voor: Opties

Submenu	Toepassing
Binnenverlichting	Schakelt de lamp in en uit.
Kinderslot	Voorkomt dat het apparaat per ongeluk wordt geactiveerd. Wanneer de optie is ingeschakeld, verschijnt de tekst Kinderslot op het display als u het apparaat inschakelt. Om het apparaat in te kunnen schakelen de codeletters in alfabetische volgorde selecteren. Toegang tot de timer, de afstandbediening en het lampje zijn beschikbaar met de optie ingeschakeld.
Snel opwarmen	Verkort de opwarmtijd. Alleen beschikbaar voor sommige functies van het apparaat.
Reinigingsherinnering	Schakelt de herinnering in en uit.
Tijdisindicatie	Schakelt de klok in en uit.
Digitale klokstijl	Wijzigt de indeling van de weergegeven tijdsaanduiding.

Submenu voor: Instelling

Submenu	Omschrijving
Taal	Stelt de taal van het apparaat in.
Helderheid display	Stelt de helderheid van de display in.
Toetstonen	Schakelt het geluid van de aanraakvelden in en uit. Het is niet mogelijk om de toon te dempen voor: ①.
Geluidsvolume	Stelt het volume van de belangrijkste geluiden en signalen in.
Waterhardheid	Stelt de waterhardheid in.

Submenu	Omschrijving
Dagtijd	Stelt de huidige tijd en datum in.

Submenu voor: Service

Submenu	Omschrijving
Demofunctie	Activerings-/deactiveringscode: 2468
Softwareversie	Informatie over softwareversie.
Terug naar fabrieksinstellingen	Herstelt fabrieksinstellingen.

Product description

General overview

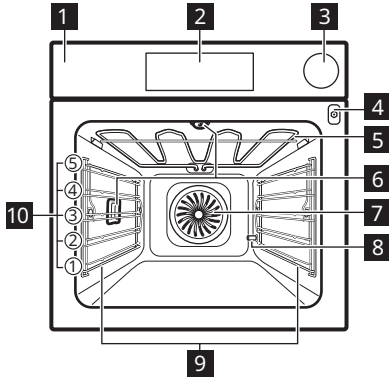

- 1** Control panel
- 2** Display
- 3** Water drawer
- 4** Socket for the food sensor
- 5** Heating element
- 6** Lamp
- 7** Fan
- 8** Descaling pipe outlet
- 9** Shelf support, removable
- 10** Shelf positions

Control panel

Control panel overview

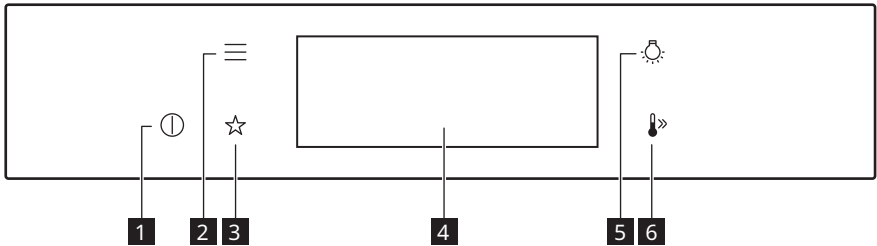

1	ON / OFF	Press and hold to turn the appliance on and off.
2	Menu	Lists the appliance functions.
3	Favourites	Lists the favourite settings.
4	Display	Shows the current settings of the appliance.

5	Lamp switch	To turn the lamp on and off.
6	Fast Heat Up	To turn on and off the function: Fast Heat Up.

Display indicators

Display with key functions.

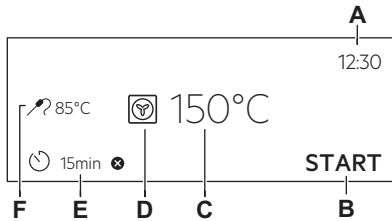

- A. Time of day
- B. START/STOP
- C. Temperature
- D. Heating functions
- E. Timer
- F. Food sensor (selected models only)

Basic indicators - to navigate on the display.

	To confirm the selection / setting.
	To go one level back in the menu.
	To undo the last action.
	To turn the options on and off.

Sound alarm function indicators - when the set time of cooking ends, the signal sounds.

	The function is on.
	The function is on. Cooking stops automatically.
	Sound alarm is off.
	To set the function: Delayed start.
	To cancel the setting.

Daily use

Heating functions

STANDARD

	True Fan Cooking: Even baking, tenderness, drying
	Conventional Cooking: Traditional baking
	Frozen Foods: French fries, potato wedges, spring rolls
	Pizza Function: Baking pizza
	Bottom Heat: Baking cakes
	Grill: Toasting, grilling
	Turbo Grilling: Roasting meat, browning

True Fan Cooking, Conventional Cooking: When you set the temperature below 80 °C the lamp automatically turns off after 30 sec.



SPECIALS

	Preserving: Preserving vegetables
--	--

	Dehydrating: Drying sliced fruit, mushrooms
	Plate Warming: Preheating plates
	Defrost: Defrosting
	Au Gratin: Making gratins, browning
	Slow Cooking: Preparing tender roast
	Keep Warm: Keeping food warm
	Moist Fan Baking: Baking

STEAM

	Easystem: Steaming, stewing, gentle crisping, baking, roasting
	Steam Regenerating: Reheating on a plate
	Bread Baking: Bread, bread rolls
	Dough Proving: Proving yeast dough
	Full Steam: Vegetables, side dishes, fish

	Humidity High: Custards, flans, terrines, fish
	Humidity Low: Meat, poultry, oven dishes, casseroles

Notes on: Moist Fan Baking

This function was used to comply with the energy efficiency class and ecodesign requirements (according to EU 65/2014 and EU 66/2014). Tests according to:

IEC/EN 60350-1

The oven door should be closed during cooking so that the function is not interrupted and the oven operates with the highest energy efficiency possible.





When you use this function the lamp automatically turns off after 30 sec.

This function is designed to save energy during cooking. When you use this function,

the temperature in the cavity may differ from the set temperature. The heating power may be reduced.

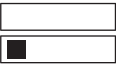
Water hardness

You can change the water hardness level in the menu: Settings / Setup / Water hardness.

Water hardness level	Test paper
1 - soft	
2 - moderately hard	
3 - hard	
4 - very hard ¹⁾	

1) When the tap water hardness level is 4, fill the water drawer with still bottled water.

Troubleshooting

If you encounter an issue with your appliance, check "Troubleshooting" chapter

in the full version of the User Manual available on: www.ikea.com.

Product Information and Product Information Sheet

Supplier's name	IKEA
Model identification	MUTEBO 105.570.41
Energy Efficiency Index	61.9
Energy efficiency class	A++
Energy consumption with a standard load, conventional mode	1.09 kWh/cycle
Energy consumption with a standard load, fan-forced mode	0.52 kWh/cycle
Number of cavities	1
Heat source	Electricity
Volume	70 l
Type of oven	Built-In Oven
Mass	35.5 kg
IEC/EN 60350-1- Household electric cooking appliances - Part 1: Ranges, ovens, steam ovens and grills - Methods for measuring performance.	

Menu structure

Menu

Menu item		Application
Assisted Cooking		Lists automatic programmes.
Cleaning		Lists cleaning programmes.
Favourites		Lists the favourite settings.
Options		To set the appliance configuration.
Settings	Setup	To set the appliance configuration.
	Service	Shows the software version and configuration.

Submenu for: Cleaning

Submenu	Application
Drying	Procedure for drying the cavity from the condensation remaining after a use of the steam functions.
Tank emptying	Procedure for removing the residual water from the water drawer after use of the steam functions.
Steam Cleaning	Light cleaning.
Steam Cleaning Plus	Thorough cleaning.
Descaling	Cleaning of the steam generation circuit from residual limestone.
Rinsing	Procedure for rinsing and cleaning the steam generation circuit after frequent use of the steam functions.

Submenu for: Options

Submenu	Application
Light	Turns the lamp on and off.
Child Lock	Prevents accidental activation of the appliance. When the option is on, the text Child Lock appears in the display when you turn on the appliance. To enable the appliance use, choose the code letters in the alphabetical order. Access to the timer, the remote operation and the lamp is available with the option on.
Fast Heat Up	Shortens the heat up time. It is available only for some of the appliance functions.
Cleaning Reminder	Turns the reminder on and off.
Time indication	Turns the clock on and off.
Digital clock style	Changes the format of the displayed time indication.

Submenu for: Setup

Submenu	Description
Language	Sets the appliance language.
Display brightness	Sets the display brightness.
Key tones	Turns the tone of the touch fields on and off. It is not possible to mute the tone for: ①.
Buzzer volume	Sets the volume of key tones and signals.
Water hardness	Sets the water hardness.
Time of day	Sets the current time and date.

Submenu for: Service

Submenu	Description
Demo mode	Activation / deactivation code: 2468
Software version	Information about software version.
Reset all settings	Restores factory settings.

Tuotekuvaus

Yleiskatsaus

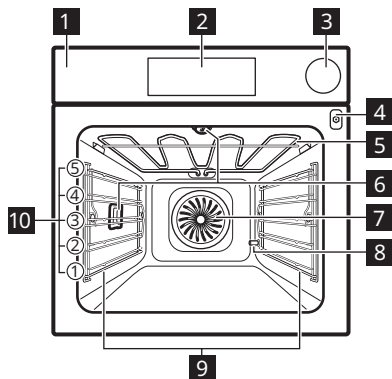

- 1** Käyttöpaneeli
- 2** Näyttö
- 3** Vesilokero
- 4** Paistolämpömittarin pistorasia
- 5** Lämpövastus
- 6** Lamppu
- 7** Puhallin
- 8** Putken poistokohdan kalkinpoisto
- 9** Hyllykannatin, irrotettava
- 10** Hyllytasot

Käyttöpaneeli

Ohjauspaneelin yleisnäkymä

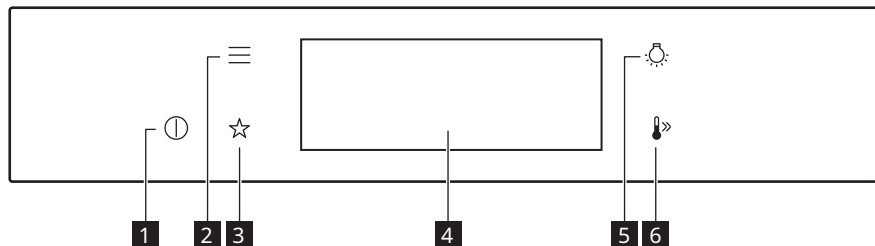

1	Päällä / Pois	Paina ja pidä painettuna laitteen kytkemiseksi toimintaan tai pois toiminnasta.
2	Valikko	Luettelee laitteen toiminnot.
3	Suosikit	Listaa omat ohjelmat
4	Näyttö	Näyttää laitteen asetukset.

5	Lampun kytkin	Kytkee lampun päälle ja pois päältä.
6	Pikakuumenennus	Toiminnon kytkeminen toimintaan ja pois toiminnasta: Pikakuumenennus.

Näytön merkkivalot

Näyttö, jossa tärkeimmät toiminnot.

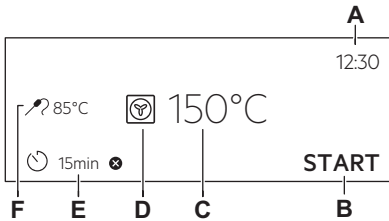

- A. Kellonaika
 B. KÄYNNISTÄ/PYSÄYTÄ
 C. Lämpötila
 D. Uunitoiminnot
 E. Ajastin
 F. Paistolämpömittari (vain tietyt mallit)

Peruserkkivalot - näytön selaaminen.

	Valinnan/asetuksen vahvistaminen.
	Valikossa siirtyminen takaisin yhden tason verran.
	Viimeisen toiminnon peruuttaminen.
	Lisätoimintojen kytkeminen toimintaan ja pois päältä.

Äänimerkki toiminnon merkkivalot - kun asetettu kypsennysaika päättyy, laitteesta kuuluu äänimerkki.

	Toiminto on päällä.
	Toiminto on päällä. Kypsentyminen pysähtyy automaattisesti.
	Hälytysäänimerkki on pois päältä.
	Toiminnon asettaminen: Ajustettu käynnistyminen.
	Asetuksen peruuttaminen.

Päivittäinen käyttö

Uunitoiminnot

VAKIOTOIMINNOT

	Kiertoilma: Tasainen lopputulos, mureus, kuivaus
	Ylä + alalämpö: Perinteinen leivonnaisten paistaminen
	Pakasteet: Ranskalaiset perunat, lohkopernat, kevätkääryleet
	Pizza-toiminto: Pizzan valmistaminen
	Alalämpö: Kakkujen paistaminen
	Grilli: Paahtaminen, grillaaminen
	Tehogrillaus: Lihan paistaminen, ruskistus

Kiertoilma, Ylä + alalämpö: Kun lämpötila on asetettu alle 80 °C:seen, lamppu sammuu automaattisesti 30 sekunnin kuluttua.



EKSTRAT

	Säilöntä: Vihannesten säilöntä
--	---------------------------------------

	Kuivattaminen: Siivutettujen hedelmien ja sienten kuivaus
	Lautasten lämmitys: Lautasten esikuuminus
	Sulatus: Pakasteiden sulatus
	Gratiinointi: Gratiinien valmistus, ruskistus
	Matalalämpö: Mureen paistin kypsentyminen
	Lämpimänä pito: Ruokien lämpimänä pito
	Kosteaa kiertoilma: Leivonnaisten paistaminen

HÖYRY

	Easystem: Höyryttäminen, hauduttaminen, kevyt ruskistus, leivonta, paistaminen
	Lämmitys höyryllä: Uudelleen lämmittämisen lautasella
	Leipä: Leipä, sämpylät
	Taikinan nostatus: Hiivataikinan nostatus

	Voimakas höyry: Vihannekset, lisäkkeet, kala
	Korkea kosteus: Vanukkaat, tortut, tertiinit, kala
	Matala kosteus: Liha, linnunliha, uunivuokaruoka, pataruoka

Huomautus: Kosteä kiertoilma

Tämän toiminnon avulla määritettiin energiatehokkuusluokka (vastaamaan standardeja EU 65/2014 ja EU 66/2014). Testit seuraavan mukaisesti:

IEC/EN 60350-1





Uunin luokun on oltava kiinni ruoanlaiton aikana, jotta toiminto ei keskeytyisi ja uunin energiatehokkuus olisi mahdollisimman suuri.

Kun valitset tämän toiminnon, lamppu sammuu automaattisesti 30 sekunnin kuluttua.

Tämä toiminto säästää energiaa ruoanlaiton aikana. Kun käytät tätä toimintoa, uunin sisälämpötila voi poiketa lämpötila-asetuksesta. Kuumennusteho voi laskea.

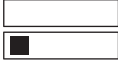
Veden kovuus

Veden kovuuden tasoa voidaan muuttaa valikossa: Asetukset / Käyttöönottoasetukset / Veden kovuus.

Vedenkovuuden taso	Testipaperi
1 - pehmeä	
2 - kohtalaisen kova	
3 - kova	
4 - erittäin kova ¹⁾	

1) Kun veden kovuuden taso on korkeampi kuin taso 4, täytä vesilokero hiilihapottomalla pullovedellä.

Vianmääritys

Jos laitteessasi on ongelmia, tarkista luku "Vianmääritys" käyttöoppaan täydestä

versiosta, joka on saatavilla osoitteessa: www.ikea.com.

Tuotetiedot ja tuotteen tietolomake

Toimittajan nimi	IKEA
Mallin tunniste	MUTEBO 105.570.41
Energiatehokkuusluokka	61.9
Energiatehokkuusluokka	A++
Energiankulutus normaalkäytössä Ylä- ja alalämpö -toiminnossa	1.09 kWh/kierrös
Energiankulutus vakiokuormalla, tuuletintila	0.52 kWh/kierrös
Pesien lukumäärä	1
Lämpölähde	Sähkö
Äänimer.voimak	70 l
Uunityyppi	Kalusteeseen asennettava uuni
Massa	35,5 kg.
IEC/EN 60350-1 - Ruoanlaittoon tarkoitettujen sähkötoimiset kodinkoneet - Osa 1: Mallistot, uunit, höyryuunit ja grillit - Menetelmiä tehon mittaukseen.	

Valikkorakenne

Valikko

Valikon kohta		Sovellus
Avustava ruoanvalmistus		Listaa automaattiset ohjelmat.
Puhdistus		Listaa puhdistusohjelmat.
Suosikit		Listaa suosikkiasetukset.
Lisätoiminnot		Laitteen asetusten määrittäminen.
Asetukset	Käyttöönottoasetukset	Laitteen asetusten määrittäminen.
	Huolto	Näyttää ohjelmistoversion ja mallin.

Alavalikko toiminnoille: Puhdistus

Alavalikko	Käyttökohde
Kuivaus	Kosteuden poistaminen uunitilasta höyrytoimintojen käyttämisen jälkeen.
Vesisäiliön tyhjennys	Jäljellä olevan veden poistaminen vesikerasta höyrytoimintojen käytön jälkeen.
Höyrypuhdistus	Kevyt puhdistus.
Höyrypuhdistus Plus	Perusteellinen puhdistus.
Kalkinpoisto	Kalkkijäämien poistaminen höyrykehittimen virtapiiristä.
Huuhtelu	Höyrykehittimen putkiston huuhteleminen ja puhdistaminen höyrytoimintojen tiheän käytön jälkeen.

Alavalikko toiminnoille: Lisätoiminnot

Alavalikko	Käyttökohde
Uunivalo	Kytkee lampun päälle ja pois
Lapsilukko	Estää laitteen tahattoman käynnistämisen. Kun lisätoiminto on päällä, teksti Lapsilukko tulee näkyviin näyttöön, kun kytket laitteen päälle. Laitteen käytön mahdollistamiseksi, valitse koodin kirjaimet aakkosjärjestyksessä. Pääsy ajastimeen, etäohjaukseen ja lampuun on mahdollista toiminnon ollessa päällä.
Pikakuumennus	Lyhentää kuumentumisaikaa. Käytettävissä vain joissakin laitteen toiminnoissa.
Muistutus puhdistamisesta	Kytkee muistutuksen päälle ja pois päältä.
Ajan näyttö	Kytkee kellon päälle ja pois päältä.
Digitaalisen kellon tyyli	Muuttaa näytössä näkyvän ajan muodon.

Alavalikko toiminnoille: Käyttöönottoasetukset

Alavalikko	Kuvaus
Kieli	Asetta laitteen kielen.
Näytön kirkkaus	Asettaa näytön kirkkauden.
Painikeäänet	Kytkee hipaisupainikkeiden äänet päälle tai pois. Äänimerkkejä ei voi poistaa käytöstä seuraavista: ①.
Äänenvoimakkuus	Asettaa painikeääniä ja signaalien äänenvoimakkuuden.
Veden kovuus	Asettaa veden kovuuden tason.
Kellonaika	Asettaa kellonajan ja päivämäärän.

Alavalikko toiminnoille: Huolto

Alavalikko	Kuvaus
Demo-toiminto	Aktivointi-/deaktivointikoodi: 2468
Ohjelmistoversio	Ohjelmistoversiota koskevia tietoja.
Palauta tehdasasetukset	Palauttaa tehdasasetukset.

Description de l'appareil

Vue d'ensemble

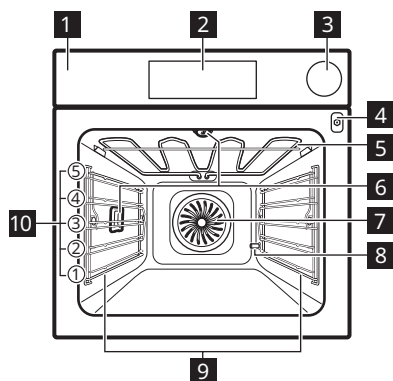

- 1 Bandeau de commande
- 2 Affichage
- 3 Bac à eau
- 4 Prise pour la sonde à viande
- 5 Résistance
- 6 Éclairage
- 7 Chaleur tournante
- 8 Sortie du tuyau de détartrage
- 9 Support de grille, amovible
- 10 Niveaux de la grille

Bandeau de commande

Vue d'ensemble du bandeau de commande

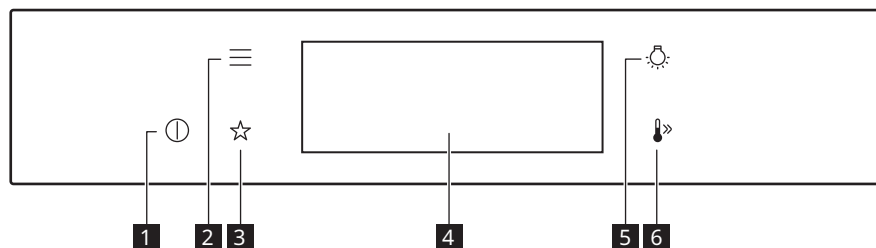

1	Activez / Désactivez	Appuyez et maintenez enfoncé pour allumer et éteindre l'appareil.
2	Menu	Répertorie les fonctions de l'appareil.
3	Mes programmes	Indique les réglages favoris.
4	Affichage	Affiche les réglages actuels de l'appareil.

5	Curseur de l'éclairage	Pour allumer et éteindre l'éclairage.
6	Préchauffage rapide	Pour activer et désactiver la fonction : Préchauffage rapide.

Voyants de l'affichage

Affichage avec les principales fonctions.

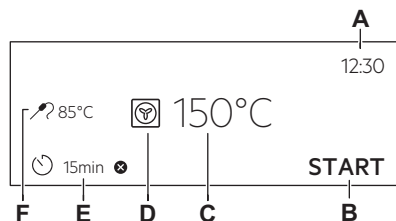

- A. Heure actuelle
- B. DEMARRER/ARRETER
- C. Température
- D. Modes de cuisson
- E. Minuteur
- F. Sonde de cuisson (uniquement sur certains modèles)

Indicateurs de base - pour naviguer dans l'affichage.

	Pour confirmer la sélection/le réglage.
	Pour remonter d'un niveau dans le menu.
	Pour annuler la dernière action.
	Pour activer et désactiver les options.

Son alarme indicateurs de fonction - lorsque la durée de cuisson programmée s'est écoulée, le signal sonore retentit.

	La fonction est activée.
	La fonction est activée. La cuisson s'arrête automatiquement.
	Le son alarme est désactivé.
	Pour régler la fonction : Départ différé.
	Pour annuler le réglage.

Utilisation quotidienne

Modes de cuisson

FONCTIONS STANDARD



	Chaleur tournante: Cuisson homogène, tendreté, séchage
	Chauffage Haut/Bas: Cuisson traditionnelle
	Plats Surgelés: Frites, pommes quartiers, rouleaux de printemps
	Fonction Pizza: Cuisson de pizza
	Chauffage inférieur: Cuisson de gâteaux
	Gril: Toaster, griller
	Turbo gril: Rôtir la viande, faire dorer

Chaleur tournante, Chauffage Haut/Bas : lorsque vous réglez la température en dessous de 80 °C, l'éclairage s'éteint automatiquement au bout de 30 secondes.

PROGRAMMES SPÉCIAUX

	Stérilisation: Stérilisation des légumes
	Déshydratation: Séchage de fruits émincés, champignons
	Chauffe-plats: Préchauffage des assiettes
	Décongélation: Décongélation
	Gratiner: Faire gratiner, dorer
	Cuisson basse température: Préparation de rôti tendre
	Maintien au chaud: Maintien au chaud des aliments
	Chaleur Tournante Humide: Cuisson

FONCTIONS VAPEUR

	Easystem: Cuire à la vapeur, faire mijoter, faire croustiller, cuire, rôtir
	Réhydratation vapeur: Réchauffer sur une assiette
	Cuisson du pain: Pain, petits pains
	Levée de pâte/pain: Faire lever la pâte
	Vapeur Intense: Légumes, garnitures, poisson
	Humidité Élevée: Crèmes anglaises, flans, terrines, poisson
	Humidité Faible: Viande, volaille, plats au four, ragoûts

Remarques sur : Chaleur Tournante Humide

Cette fonction était utilisée pour se conformer à la classe d'efficacité énergétique et aux exigences Ecodesign (selon les normes EU 65/2014 et EU 66/2014). Tests conformes aux normes :

IEC/EN 60350-1





La porte du four doit être fermée pendant la cuisson pour que la fonction ne soit pas interrompue et que le four fonctionne avec la plus grande efficacité énergétique possible.

Lorsque vous utilisez cette fonction, l'éclairage s'éteint automatiquement au bout de 30 secondes.

Cette fonction est conçue pour économiser de l'énergie en cours de cuisson. Lorsque vous utilisez cette fonction, la température à l'intérieur de la cavité peut différer de la température sélectionnée. La puissance peut être réduite.

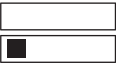
Dureté de l'eau

Vous pouvez changer le niveau de dureté de l'eau dans le menu : Configurations / Configuration / Dureté de l'eau.

Niveau de dureté de l'eau	Papier réactif
1 - douce	
2 - modérément dure	
3 - dure	
4 - très dure¹⁾	

1) Si le niveau de dureté de l'eau du robinet est de 4, remplissez le bac à eau avec de l'eau plate en bouteille.

Dépannage

Si vous rencontrez un problème avec votre appareil, consultez le chapitre « Dépannage » dans la version complète du

Manuel de l'utilisateur disponible sur : www.ikea.com.

Informations produit et fiche d'informations produit

Nom du fournisseur	IKEA
Identification du modèle	MUTEBO 105.570.41
Indice d'efficacité énergétique	61.9
Classe d'efficacité énergétique	A++
Consommation d'énergie avec charge standard, en mode conventionnel	1.09 kWh/cycle
Consommation d'énergie avec charge standard, en mode chaleur tournante	0.52 kWh/cycle
Nombre de cavités	1

Source de chaleur	Électricité
Volume	70 l
Type de four	Four encastrable
Masse	35,5 kg
IEC/EN 60350-1 - Appareils de cuisson domestiques électriques - Partie 1 : Cuisinières, fours, fours à vapeur et grils : Méthodes de mesure des performances.	

Structure des menus

Menu

Élément du menu		Application
Cuisson assistée		Indique les programmes automatiques.
Nettoyage		Indique les programmes de nettoyage.
Mes programmes		Indique les réglages favoris.
Options		Pour régler l'appareil.
Configurations	Configuration	Pour régler l'appareil.
	Service	Affiche la version et la configuration du logiciel.

Sous-menu pour : Nettoyage

Sous-menu	Application
Séchage	Procédure de séchage de la cavité pour éliminer la condensation qui se forme pendant l'utilisation des fonctions vapeur.
Vidange du réservoir	Procédure pour éliminer l'eau résiduelle du bac à eau après avoir utilisé les fonctions de vapeur.
Nettoyage vapeur	Nettoyage léger
Nettoyage Vapeur Plus	Nettoyage complet.
Détartrage	Nettoyage du circuit de génération de la vapeur des résidus calcaires.
Rinçage	La procédure de rinçage et de nettoyage du circuit du générateur de vapeur après une utilisation fréquente des fonctions vapeur.

Sous-menu pour : Options

Sous-menu	Application
Eclairage four	Allume et éteint l'éclairage.
Sécurité enfants	Empêche l'activation accidentelle de l'appareil. Lorsque l'option est activée, le texte Sécurité enfants s'affiche lorsque vous allumez l'appareil. Pour permettre l'utilisation de l'appareil, choisissez les lettres du code dans l'ordre alphabétique. L'accès au minuteur, à la télécommande et à l'éclairage est possible avec l'option activée.
Préchauffage rapide	Réduit la durée de préchauffage. L'option n'est disponible que pour certaines fonctions de l'appareil.
Nettoyage conseillé	Active et désactive le rappel.
Indication Du Temps	Allume et éteint l'horloge.
Affichage Heure	Change le format de l'affichage de l'heure.

Sous-menu pour : Configuration

Sous-menu	Description
Langue	Définit la langue de l'appareil.
Affichage Luminosité	Règle la luminosité de l'affichage.
Son touches	Active et désactive la tonalité des champs tactiles. Il n'est pas possible de couper la tonalité pour : ①.
Volume alarme	Règle le volume des signaux sonores et des tonalités des touches.
Dureté de l'eau	Définit la dureté de l'eau.
Heure actuelle	Règle l'heure et la date actuelles.

Sous-menu pour : Service

Sous-menu	Description
Mode démo	Code d'activation / de désactivation : 2468
Version du logiciel	Informations sur la version logicielle.
Réinitialiser tous les réglages	Restaure les réglages d'usine.

Gerätebeschreibung

Gesamtansicht

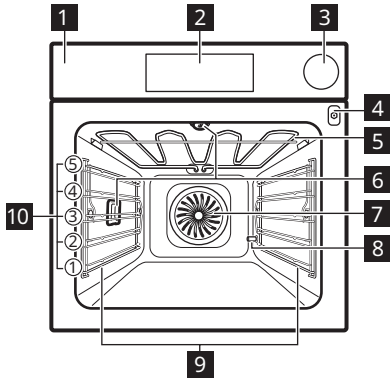

- 1 Bedienfeld
- 2 Display
- 3 Wassertank
- 4 Buchse für den Temperatursensor
- 5 Heizelement
- 6 Lampe
- 7 Ventilator
- 8 Entkalkungsrohr Ausgang
- 9 Einschubschienen, herausnehmbar
- 10 Einschubebenen

Bedienfeld

Überblick - Bedienfeld

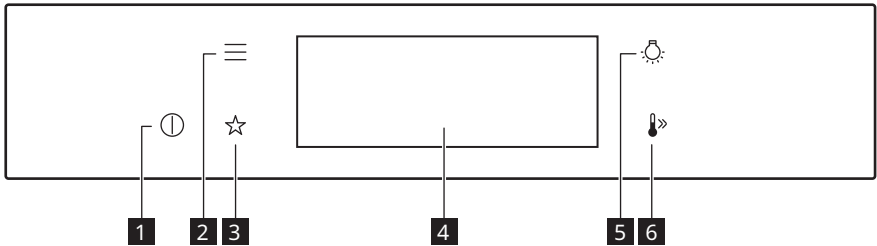

1	EIN / AUS	Gedrückt halten, um das Gerät ein- und auszuschalten.
2	Menü	Listet die Gerätefunktionen auf.
3	Favoriten	Liste der bevorzugten Einstellungen.
4	Display	Zeigt die aktuellen Einstellungen des Geräts an.

5	Lichtschalter	Ein- und Ausschalten der Beleuchtung.
6	Schnellaufheizung	Ein- und Ausschalten der Funktion: Schnellaufheizung.

Display-Anzeigen

Display mit Tastenfunktionen.

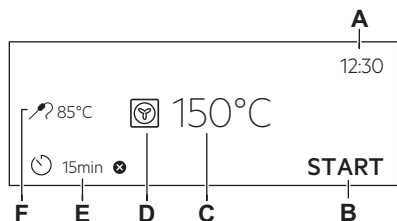

- A. Uhrzeit
- B. START/STOP
- C. Temperatur
- D. Ofenfunktionen
- E. Kurzzeitwecker
- F. Temperatursensor (nur ausgewählte Modelle)

Grundlegende Anzeigen - Navigieren im Display.

	Bestätigen der Auswahl / Einstellung.
	Zurückblättern um eine Menüebene.
	Rückgängig machen der letzten Aktion.
	Ein- und Ausschalten der Optionen.

Alarmsignal Funktionsanzeigen – der Signalton ertönt nach Ablauf der eingestellten Kochzeit.

	Die Funktion ist eingeschaltet.
	Die Funktion ist eingeschaltet. Der Garvorgang stoppt automatisch.
	Das Alarmsignal ist ausgeschaltet.
	Einstellen der Funktion: Zeitvorwahl.
	Abbrechen der Einstellung.

Täglicher Gebrauch

Ofenfunktionen

STANDARDFUNKTIONEN

	Heißluft: Gleichmäßiges Backen, Zartheit, Dörren
	Ober-/Unterhitze: Traditionelles Backen
	Tiefkühlgerichte: Pommes frites, Kartoffelspalten, Frühlingsrollen
	Pizzastufe: Backen von Pizza
	Unterhitze: Kuchen backen
	Grill: Toasten, Grillen
	Heißluftgrillen: Braten von Fleisch, Bräunen





Heißluft, Ober-/Unterhitze: Wenn Sie die Temperatur auf unter 80 °C einstellen, schaltet sich die Lampe nach 30 Sekunden automatisch aus.

SONDERFUNKTIONEN

	Einkochen: Gemüse einkochen
	Dörren: Dörren von Obst und Pilzen in Scheiben
	Teller wärmen: Vorheizplatten
	Auftauen: Auftauen
	Überbacken: Gratins zubereiten, Bräunen
	Niedertemperaturgaren: Zubereitung von zartem Braten
	Warmhalten: Warmhalten von Speisen
	Feuchte Umluft: Backen

DAMPFFUNKTIONEN

	Easystem: Dämpfen, Dünsten, sanftes Grillen, Backen, Braten
	Regenerieren: Aufwärmen auf einem Teller
	Brot backen: Brot, Brötchen

	Gärstufe: Gehen von Hefeteig
	Dampfgaren: Gemüse, Beilagen, Fisch
	Feuchtigkeit, hoch: Pudding, Flans, Terrinen, Fisch
	Feuchtigkeit, niedrig: Fleisch, Geflügel, Ofengerichte, Aufläufe

Hinweise zu: Feuchte Umluft

Diese Funktion wurde zur Einhaltung der Energieeffizienzklasse und der Ökodesign-Anforderungen (gemäß EU 65/2014 und EU 66/2014) verwendet. Tests gemäß: IEC/EN 60350-1





Die Backofentür sollte während des Garvorgangs geschlossen bleiben, damit die Funktion nicht unterbrochen wird. So wird gewährleistet, dass der Backofen mit der höchsten Energieeffizienz arbeitet.

Wenn Sie diese Funktion verwenden, schaltet sich die Backofenbeleuchtung automatisch nach 30 Sekunden aus.

Diese Funktion ist entwickelt worden, um während des Kochvorgangs Energie zu sparen. Wenn Sie diese Funktion nutzen, kann die Temperatur im Garraum von der eingestellten Temperatur abweichen. Die Wärmeleistung kann geringer sein.

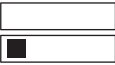
Wasserhärte

Sie können die Wasserhärte in folgendem Menü ändern: Einstellungen / Setup / Wasserhärte.

Wasserhärtegrad	Reagenzpapier
1 - weich	
2 - mittelhart	
3 - hart	
4 - sehr hart¹⁾	

1) Beträgt der Grad der Wasserhärte 4, füllen Sie den Wassertank mit Tafelwasser.

Problembekämpfung

Wenn Sie ein Problem mit Ihrem Gerät haben, lesen Sie das Kapitel „Fehlerbekämpfung“ in der Vollversion des

Benutzerhandbuchs, das auf folgenden Seiten verfügbar ist: www.ikea.com.

Produktinformationen und Produktinformationsblatt

Name des Lieferanten	IKEA
Modellbezeichnung	MUTEBO 105.570.41
Energieeffizienzindex	61.9
Energieeffizienzklasse	A++
Energieverbrauch mit einer Standardbeladung, konventioneller Modus	1.09 kWh/Programm
Energieverbrauch mit einer Standardbeladung, Umluft-Modus	0.52 kWh/Programm
Anzahl der Garräume	1
Wärmequelle	Strom
Volumen	70 l
Art des Backofens	Eingebauter Backofen
Masse	35.5 kg
IEC/EN 60350-1 – Elektrische Kochgeräte für den Hausgebrauch – Teil 1: Stufen, Backöfen, Dampfofen und Grills – Methoden zur Leistungsmessung.	

Menüstruktur

Menü

Menüpunkt		Gerät
Koch-Assistent		Liste der automatischen Programme.
Reinigung		Liste der Reinigungsprogramme.
Favoriten		Liste der bevorzugten Einstellungen.
Optionen		Konfigurieren des Geräts.
Einstellungen	Setup	Konfigurieren des Geräts.
	Service	Anzeige der Softwareversion und Konfiguration.

Untermenü für: Reinigung

Untermenü	Gerät
Trocknen	Verfahren zum Trocknen der Kondensation im Garraum nach Verwendung einer der Dampffunktionen.
Entleeren des Wassertanks	Programm zum Entleeren des Restwassers aus dem Wassertank nach Verwendung der Dampffunktionen.
Dampfreinigung	Leichte Reinigung.
Dampfreinigung Plus	Gründliche Reinigung.
Entkalkung	Entfernen von Kalkrückständen aus dem Dampfgenerator-Kreislauf.
Spülen	Programm zum Spülen und Reinigen des Dampfgenerator-Kreislaufs nach häufiger Verwendung der Dampffunktionen.

Untermenü für: Optionen

Untermenü	Anwendung
Backofenbeleuchtung	Ein- und Ausschalten der Beleuchtung.
Kindersicherung	Verhindert ein versehentliches Einschalten des Geräts. Wenn die Option aktiviert ist, erscheint der Text Kindersicherung im Display, wenn Sie das Gerät einschalten. Um das Gerät verwenden zu können, wählen Sie die Buchstaben des Codes in alphabetischer Reihenfolge. Der Zugriff auf den Timer, die Fernsteuerung und die Lampe ist möglich, wenn die Option aktiviert ist.
Schnellaufheizung	Verringert die Aufheizzeit. Es ist nur für einige Gerätefunktionen verfügbar.
Erinnerungsfunktion Reinigen	Ein- und Ausschalten der Erinnerungsfunktion.
Zeitanzeige	Ein- und Ausschalten der Uhr.
Digitale Uhrzeitanzeige	Ändern des Formats der angezeigten Uhrzeit.

Untermenü für: Setup

Untermenü	Beschreibung
Sprache	Legt die Sprache des Geräts fest.
Helligkeit	Auswahl der Helligkeit.
Tastentöne	Ein- und Ausschalten der Tastentöne der Sensorfelder. Es ist nicht möglich, den Signalton für Folgendes stummzuschalten: ①.
Lautstärke	Einstellen der Lautstärke der Tastentöne und Signale.
Wasserhärte	Einstellen der Wasserhärte.
Uhrzeit	Einstellen der aktuellen Uhrzeit und des Datums.

Untermenü für: Service

Untermenü	Beschreibung
DEMO	Aktivierungs-/Deaktivierungscode: 2468
Softwareversion	Informationen zur Softwareversion.
Gerät auf Werkseinstellungen zurücksetzen	Wiederherstellung der Werkseinstellungen.

Περιγραφή προϊόντος

Γενική επισκόπηση

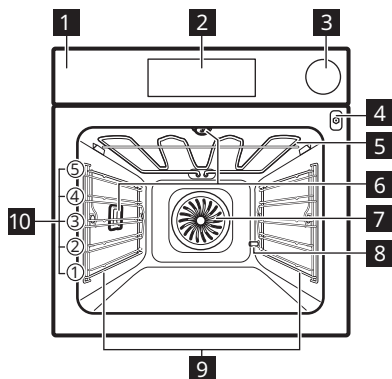

- 1** Πίνακας χειριστηρίων
- 2** Οθόνη
- 3** Θήκη νερού
- 4** Υποδοχή αισθητήρα φαγητού
- 5** Αντίσταση
- 6** Λαμπτήρας
- 7** Ανεμιστήρας
- 8** Αφαίρεση αλάτων από έξοδο σωλήνα
- 9** Στήριξη ραφιού, αφαιρούμενη
- 10** Θέσεις ραφιού

Πίνακας χειριστηρίων

Επισκόπηση πίνακα χειριστηρίων

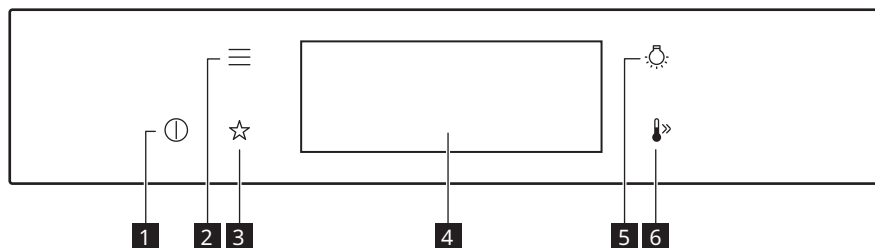

1	ON / OFF	Πιέστε παρατεταμένα για να ενεργοποιήσετε και να απενεργοποιήσετε τη συσκευή.
2	Μενού	Παραθέτει τις λειτουργίες της συσκευής.
3	Αγαπημένα	Παραθέτει τις αγαπημένες ρυθμίσεις.
4	Οθόνη	Εμφανίζει τις τρέχουσες ρυθμίσεις της συσκευής.

5	Διακόπτης λαμπτήρα	Για ενεργοποίηση και απενεργοποίηση του λαμπτήρα.
6	Ταχεία προθέρμανση	Για ενεργοποίηση και απενεργοποίηση της λειτουργίας: Ταχεία προθέρμανση.

Ενδείξεις οθόνης

Οθόνη με λειτουργίες πλήκτρων.

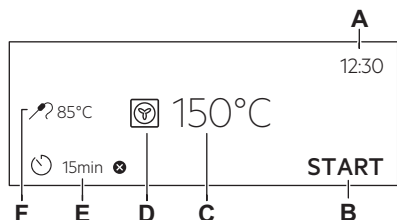

Βασικές ενδείξεις - για την πλοήγηση στην οθόνη.

	Για επιβεβαίωση της επιλογής / ρύθμισης.
	Για μετάβαση κατά ένα επίπεδο πίσω στο μενού.
	Για αναίρεση της προηγούμενης ενέργειας.
	Για την ενεργοποίηση και απενεργοποίηση των επιλογών.

- A. Ώρα
- B. ΕΝΑΡΞΗ/ΔΙΑΚΟΠΗ
- C. Θερμοκρασία
- D. Προγράμματα θέρμανσης
- E. Χρονοδιακόπτης
- F. Αισθ. Φαγητού (μόνο σε επιλεγμένα μοντέλα)

Ηχητική προειδοποίηση Ενδείξεις λειτουργίας - μόλις παρέλθει ο ρυθμισμένος χρόνος μαγειρέματος, ακούγεται το σήμα.

	Η λειτουργία είναι ενεργοποιημένη.
	Η λειτουργία είναι ενεργοποιημένη. Το μαγείρεμα σταματά αυτόματα.
	Η ηχητική προειδοποίηση είναι απενεργοποιημένη.
	Για ρύθμιση της λειτουργίας: Χρονοκαυστέρηση έναρξης.
	Για ακύρωση της ρύθμισης.

Καθημερινή χρήση

Προγράμματα

ΒΑΣΙΚΟ

	Θερμός Αέρας: Ομοιόμορφο ψήσιμο, τρυφεράδα, ξήρανση
	Πάνω/Κάτω Θέρμανση: Παραδοσιακό ψήσιμο
	Καταψυγμένα τρόφιμα: Τηγανιτές πατάτες, πατάτες κυδωνάτες, σπρινγκ ρολς
	Λειτουργία Πίτσα: Ψήσιμο πίτσας
	Κάτω Θέρμανση: Ψήσιμο κέκι
	Γκριλ: Φρυγάνισμα, ψήσιμο στο γκριλ
	Γκριλ με Θερμό Αέρα: Ψήσιμο κρέατος, ρόδισμα





Θερμός Αέρας, Πάνω/Κάτω Θέρμανση: Όταν ρυθμίζετε τη θερμοκρασία κάτω των 80 °C, ο λαμπτήρας απενεργοποιείται αυτόματα μετά από 30 δευτ.

ΕΙΔΙΚΑ ΠΡΟΓΡΑΜΜΑΤΑ

	Διατήρηση: Συντήρηση λαχανικών
	Αποξήρανση: Ξήρανση φρούτων σε φέτες, μανιτάρια
	Ζέσταμα πιάτων: Προθέρμανση πιάτων
	Απόψυξη: Απόψυξη
	Ογκρατέν: Γκρατινάρισμα, ρόδισμα
	Χαμηλή Θερμοκρασία: Προετοιμασία τρυφερού ψητού
	Διατήρηση Θερμότητας: Διατήρηση του φαγητού ζεστού
	Υγρός Θερμός Αέρας : Ψήσιμο

ΑΤΜΟΣ

	Easystem: Μαγείρεμα με ατμό, σιγοβράσιμο, δημιουργία κρούστας, ψήσιμο
	Ζέσταμα με ατμό: Ξαναζέσταμα σε ένα πιάτο

	Ψήσιμο Ψωμιού: Ψωμί, ψωμάκια
	Φούσκωμα ζύμης: Φούσκωμα ζύμης με μαγιά
	Ατμός Vital: Λαχανικά, συνοδευτικά πιάτα, ψάρι
	Υψηλή Υγρασία: Κρέμες, τάρτες, τερίν, ψάρι
	Χαμηλή Υγρασία: Κρέας, πουλερικά, Φαγητά Φούρνου, γάστρα

Σημειώσεις σχετικά με: Υγρός Θερμός Αέρας

Αυτή η λειτουργία χρησιμοποιήθηκε για συμμόρφωση με την τάξη ενεργειακής απόδοσης και τις απαιτήσεις για τον οικολογικό σχεδιασμό (σύμφωνα με EU 65/2014 και EU 66/2014). Δοκιμές σύμφωνα με το:

IEC/EN 60350-1





Η πόρτα του φούρνου θα πρέπει να είναι κλειστή κατά τη διάρκεια του μαγειρέματος, έτσι ώστε η λειτουργία να μη διακόπτεται και ο φούρνος να λειτουργεί με την υψηλότερη δυνατή ενεργειακή απόδοση.

Όταν χρησιμοποιείτε αυτήν τη λειτουργία, ο λαμπτήρας απενεργοποιείται αυτόματα μετά από 30 δευτερόλεπτα.

Αυτή η λειτουργία σχεδιάστηκε για να εξοικονομεί ενέργεια κατά το ψήσιμο. Όταν χρησιμοποιείτε αυτή τη λειτουργία, η θερμοκρασία στο εσωτερικό του φούρνου μπορεί να διαφέρει από τη ρυθμισμένη θερμοκρασία. Η θερμομαντική ισχύς μπορεί να μειωθεί.

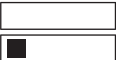
Σκληρότητα νερού

Μπορείτε να αλλάξετε το επίπεδο σκληρότητας του νερού στο μενού: Ρυθμίσεις / Ρύθμιση / Σκληρότητα νερού.

Επίπεδο σκληρότ. νερού	Δοκιμαστικό χαρτί
1 - μαλακό	
2 - μέτρια σκληρό	
3 - σκληρό	
4 - πολύ σκληρό¹⁾	

¹⁾ Όταν το επίπεδο σκληρότητας του νερού βρύσης είναι 4, γεμίζετε τη θήκη νερού με εμφιαλωμένο νερό.

Επίλυση προβλημάτων

Εάν αντιμετωπίσετε κάποιο πρόβλημα με τη συσκευή σας, ανατρέξτε στο κεφάλαιο «Αντιμετώπιση προβλημάτων» στην πλήρη

έκδοση του Εγχειριδίου Χρήστη που διατίθεται στη διεύθυνση: www.ikea.com.

Πληροφορίες προϊόντος και Φύλλο πληροφοριών προϊόντος

Όνομα προμηθευτή	IKEA
Ταυτότητα μοντέλου	MUTEBO 105.570.41
Δείκτης ενεργειακής απόδοσης	61.9
Τάξη ενεργειακής απόδοσης	A++
Κατανάλωση ενέργειας με βασικό φορτίο, συμβατική λειτουργία	1.09 kWh/κύκλο
Κατανάλωση ενέργειας με βασικό φορτίο, λειτουργία με υποβοήθηση ανεμιστήρα	0.52 kWh/κύκλο

Αριθμός κοιλοτήτων	1
Πηγή θερμότητας	Ηλεκτρική ενέργεια
Ένταση	70 l
Τύπος φούρνου	Εντοιχιζόμενος φούρνος
Μάζα	35,5 kg
IEC/EL 60350-1 - Οικιακές ηλεκτρικές συσκευές μαγειρέματος - Μέρος 1: Σειρές, φούρνοι, φούρνοι ατμού και γκριλ - Μέθοδοι μέτρησης της απόδοσης.	

Δομή μενού

Μενού

Στοιχείο μενού		Εφαρμογή
Μαγείρεμα με βοήθεια		Παραθέτει τα αυτόματα προγράμματα.
Καθαρισμός		Παραθέτει τα προγράμματα καθαρισμού.
Αγαπημένα		Παραθέτει τις αγαπημένες ρυθμίσεις.
Επιλογές		Για τη ρύθμιση της διαμόρφωσης της συσκευής.
Ρυθμίσεις	Ρύθμιση	Για τη ρύθμιση της διαμόρφωσης της συσκευής.
	Σέρβις	Προβάλλει την έκδοση του λογισμικού και τη διαμόρφωση.

Υπομενού για : Καθαρισμός

Υπομενού	Εφαρμογή
Ξήρανση	Διαδικασία για το στέγνωμα του εσωτερικού του φούρνου από τη συμπύκνωση που παραμένει μετά από τη χρήση των λειτουργιών ατμού.
Άδειασμα δοχείου	Διαδικασία για την αφαίρεση του υπολειπόμενου νερού από τη θήκη νερού μετά τη χρήση των λειτουργιών ατμού.
Καθάρισμα με ατμό	Ελαφρύς καθαρισμός.
Καθάρισμα με ατμό Plus	Σχολαστικός καθαρισμός.
Αφαίρεση αλάτων	Καθαρισμός του κυκλώματος της γεννήτριας ατμού από επικαθίσεις αλάτων.
Ξέβγαλμα	Διαδικασία για ξέβγαλμα και καθαρισμό του κυκλώματος της γεννήτριας ατμού έπειτα από συχνή χρήση των λειτουργιών ατμού.

Υπομενού για : Επιλογές

Υπομενού	Εφαρμογή
Φωτισμός Φούρνου	Ενεργοποιεί και απενεργοποιεί τον λαμπτήρα.
Κλειδ. ασφ. για παιδ.	Αποτρέπει την ακούσια ενεργοποίηση της συσκευής. Όταν η επιλογή είναι ενεργοποιημένη, το κείμενο Κλειδ. ασφ. για παιδ. εμφανίζεται στην ένδειξη όταν ενεργοποιείτε τη συσκευή. Για να γίνει δυνατή η χρήση της συσκευής, επιλέξτε τα κωδικά γράμματα με αλφαβητική σειρά. Η πρόσβαση στον χρονοδιακόπτη, η απομακρυσμένη λειτουργία και ο λαμπτήρας είναι διαθέσιμα με την επιλογή ενεργοποιημένη.
Ταχεία προθέρμανση	Μειώνει τον χρόνο προθέρμανσης. Είναι διαθέσιμη μόνο για μερικές από τις λειτουργίες της συσκευής.
Υπενθύμιση Καθαρισμού	Ενεργοποιεί και απενεργοποιεί την υπενθύμιση.
Ένδειξη Χρόνου	Ενεργοποιεί και απενεργοποιεί το ρολόι.
Ψηφιακό στυλ ρολογιού	Αλλάζει τη μορφή της εμφανιζόμενης ένδειξης ώρας.

Υπομενού για : Ρύθμιση

Υπομενού	Περιγραφή
Γλώσσα	Ρυθμίζει τη γλώσσα της συσκευής.
Φωτεινότητα Οθόνης	Ρυθμίζει τη φωτεινότητα της οθόνης.
Ήχοι Πλήκτρων	Ενεργοποιεί και απενεργοποιεί τον ήχο των πεδίων αφής. Δεν είναι δυνατή η σίγαση του ήχου για: ①.
Ένταση Βομβητή	Ρυθμίζει την ένταση του ήχου των πλήκτρων και των σημάτων.
Σκληρότητα νερού	Ρυθμίζει τη σκληρότητα του νερού.
Ωρα	Ρυθμίζει την τρέχουσα ώρα και ημερομηνία.

Υπομενού για : Σέρβις

Υπομενού	Περιγραφή
Λειτουργία Demo	Κωδικός ενεργοποίησης / απενεργοποίησης: 2468
Έκδοση λογισμικού	Πληροφορίες σχετικά με την έκδοση λογισμικού.
Επαναφορά όλων των ρυθμίσεων	Επαναφέρει τις εργοστασιακές ρυθμίσεις.

Vörulýsing

Almennt yfirlit

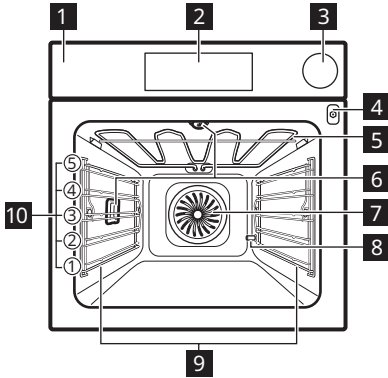

- 1** Stjórnborð
- 2** Skjár
- 3** Vatnsskúffa
- 4** Innstunga fyrir matvælaskynjara
- 5** Hitunareining
- 6** Ljós
- 7** Vifta
- 8** Kalkhreinsun rörúttaks
- 9** Hilluberarar, lausir
- 10** Hillustöður

Stjórnborð

Yfirlit yfir stjórnborð

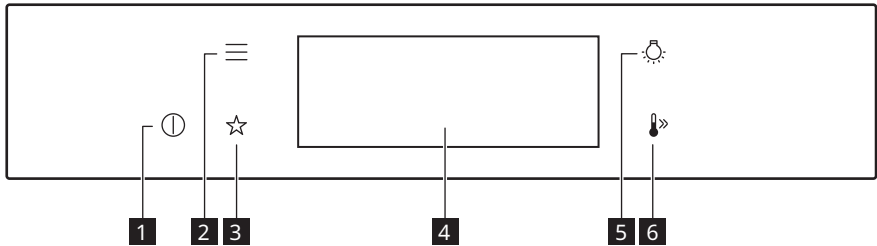

1	KVEIKT / SLÖKKT	Ýttu á og haltu inni til að kveikja og slökkva á heimilistækinu.
2	Valmynd	Sýnir lista yfir aðgerðir heimilistækisins.
3	Uppáhalds	Sýnir lista yfir upphaldsstillingar.
4	Skjár	Sýnir núverandi stillingar heimilistækisins.

5	Ljósrofi	Til að kveikja og slökkva á ljósinu.
6	Hröð upphitun	Til að kveikja og slökkva á aðgerðinni: Hröð upphitun.

Skjávísar

Skjár með lykilaðgerðum.

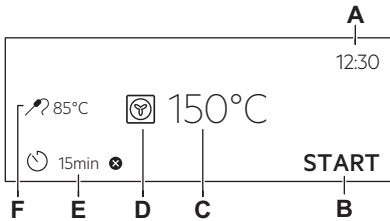

- A. Tími dags
- B. BYRJA/STÖÐVA
- C. Hitastig
- D. Upphitunaraðgerðir
- E. Tímastillir
- F. Matvælaskynjari (aðeins valdar gerðir)

Grunnvísar - til að vafra um skjáinn.

	Til að staðfesta valið / stillinguna.
	Til að fara eitt stig til baka í valmyndinni.
	Til að afturkalla síðustu aðgerð.
	Til að kveikja og slökkva á valkostunum.

Hljóðmerki aðgerðarvísar - þegar stilltum eldunartíma er lokið, heyrst hljóðmerki.

	Kveikt er á virkninni.
	Kveikt er á virkninni. Eldun stöðvast sjálfkrafa.
	Slökkt er á hljóðviðvörðun.
	Til að stilla aðgerðina Seinkuð ræsing.
	Til að afturkalla stillinguna.

Dagleg notkun

Upphitunaraðgerðir

STAÐLAD

	Eldun með hefðbundnum blæstri: Jöfn bakstur, meyrnun, þurrkun
	Hefðbundin matreiðsla: Hefðbundinn bakstur
	Frosin matvæli: Franskar kartöflur, kartöflubátar, vorrúllur
	Pítsuaðgerð: Pítsubakstur
	Undirhiti: Kökubakstur
	Grill: Ristun, grillun
	Blástursgrillun: Steiking á kjöti, brúnun



Eldun með hefðbundnum blæstri, Hefðbundin matreiðsla: Þegar þú stillir hitastigið undir 80°C slökknar sjálfkrafa á ljósinu eftir 30 sek.

SÉRAÐGERÐIR

	Niðursuða: Varðveisla grænmetis
	Þurrkun: Þurrkun á niðurskornun ávöxtum, sveppum
	Upphitun disks: Upphitun á diskum
	Affrysta: Affrýsting
	Gratínera: Eldun á gratíni, brúnun
	Hægeldun: Meyr steik elduð
	Halda hita: Halda mat heitum
	Bökun með rökum blæstri: Bakstur

GUFA

	Easysystem: Gufueldun, pottréttir, létt steiking, bakstur, steiking
	Gufumyndandi: Upphitun á disk
	Brauðbakstur: Brauð, brauðrúllur
	Hefun deigs: Láta gerdeig hefast

	Full gufa: Grænmeti, meðlæti, fiskur
	Raki mikill: Búðingur, bökur, kæfa, fiskur
	Raki lítil: Kjöt, fuglakjöt, ofnréttir, pottréttir

Athugasemdir varðandi: Bökun með rökum blæstri

Þessi aðgerð var notuð til að uppfylla skilyrði flokkunar á orkunýtni og vishönnunar (í samræmi við EU 65/2014 og EU 66/2014). Prófanir í samræmi við:

IEC/EN 60350-1

Ofnhurðin ætti að vera lokuð meðan á matreiðslu stendur þannig að aðgerðin verði ekki fyrir truflun og til þess að ofninn virki með bestu mögulegu orkunýtni.





Þegar þú notar þessa aðgerð slokknar ljósið sjálfkrafa eftir 30 sek.

Þessi aðgerð er hönnuð til að spara orku á meðan eldað er. Þegar þú notar þessa

aðgerð kann hitastigið í rýminu að vera frábrugðið innstilltu hitastigi. Hitunarkraftur kann að vera minni.

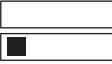
Harka vatns

Þú getur breytt hörkustigi vatnsins í valmyndinni: Stillingar / Uppsetning / Harka vatns.

Hörkustig vatns	Prófunarpappír
1 - mjúkt	
2 - miðlungs hart	
3 - hart	
4 - mjög hart 1)	

1) Þegar hörkustig kranavatnsins er 4 skaltu fylla vatnsskúffuna með flöskuvatni án kolsýru.

Bilanaleit

Ef þú upplifir vandamál með heimilistækið þitt skaltu skoða „Bilanaleit“ kaflann í fullri

útgáfu notendahandbókarinnar sem er fánleg hjá: www.ikea.com.

Vöruupplýsingar og vöruupplýsingaskjal

Heiti birgja	IKEA
Auðkenni tegundar	MUTEBO 105.570.41
Orkunýtnistuðull	61.9
Orkunýtniflokkur	A++
Orkunotkun með staðlaðri hleðslu, hefðbundinn hamur	1.09 kWh/lotu
Orkunotkun með staðlaðri hleðslu, víftudrifinn hamur	0.52 kWh/lotu
Fjöldi holrýma	1
Hítagjafi	Rafmagn
Hljóðstyrkur	70 l
Tegund ofns	Innbyggður ofn
Massi	35.5 kg
IEC/EN 60350-1- Rafmagnseldunartæki til heimilisnota - 1. hluti: Svið, ofnar, gufufnar og grill - Tegundir afkastamælinga.	

Skipulag valmyndar

Valmynd

Réttur á matseðli		Notkun
Eldunaraðstoð		Dregur upp lista af sjálfvirkum kerfum.
Hreinsun		Dregur upp lista af hreinsikerfum.
Uppáhalds		Sýnir lista yfir uppáhaldsstillingar.
Valkostir		Til að stilla grunnstillingu heimilistækisins.
Stillingar	Uppsetning	Til að stilla grunnstillingu heimilistækisins.
	Þjónusta	Sýnir útgáfu hugbúnaðarins og samskipan.

Undirvalmynd fyrir: Hreinsun

Undirvalmynd	Notkun
Þurrkun	Ferlið við það að þurrka holrýmið af uppsöfnuðum raka eftir notkun á gufuaðgerðum.
Tankur að tæmast	Verklag við að fjarlægja afgangsvatnið úr vatnsskúffunni eftir notkun gufuaðgerða.
Gufuhreinsun	Létt hreinsun.
Hreinsað með gufu Plús	Ítarleg hreinsun.
Kalkhreinsun	Hreinsun á kalkleifum úr gufuketilshringrásinni.
Skolon	Verklag við að skola og hreinsa hringrás gufuketils eftir tíða notkun gufuaðgerðanna.

Undirvalmynd fyrir: Valkostir

Undirvalmynd	Notkun
Létt	Kveikir og slekkur á ljósinu.
Barnalæsing	Kemur í veg fyrir að kveikt sé á heimilistækinu fyrir slysi. Þegar kveikt er á valkostinum mun textinn Barnalæsing birtast á skjánum þegar þú kveikir á heimilistækinu. Til að virkja notkun heimilistækisins skaltu velja stafina í kóðanum eftir stafrófsröð. Aðgangur að tímatöku, fjarstýringu og ljósi er mögulegur þegar kveikt er á valkostinum.
Hröð upphitun	Styttir upphitunartímann. Það er aðeins í boði fyrir sumar aðgerðir heimilistækisins.
Áminning um hreinsun	Kveikir og slekkur á áminningunni.
Tímavísun	Kveikir og slekkur á klukkunni.
Útlit stafrænnar klukku	Breytir framsetningu á birtingu tímans.

Undirvalmynd fyrir: Uppsetning

Undirvalmynd	Lýsing
Tungumál	Stillir tungumál heimilistækisins.
Skjábirta	Stillir birtustigið.
Lykiltónar	Kveikir og slekkur á hljóði fyrir snertifleti. Ekki er mögulegt að slökkva á hljóði fyrir: ①.
Hljóðstyrkur hljóðgjafa	Stillir hljóðstyrk fyrir takka og merki.
Harka vatns	Stillir hörkustig vatns.
Tími dags	Stillir núverandi tíma og dagsetningu.

Undirvalmynd fyrir: Þjónusta

Undirvalmynd	Lýsing
Kynningarhamur	Virkjunar- / afvirkjunarkóði: 2468
Útgáfa hugbúnaðar	Upplýsingar um hugbúnaðarútgáfu.
Endursetja allar stillingar	Endurstillir verksmiðjustillingar.

Descrizione del prodotto

Panoramica generale

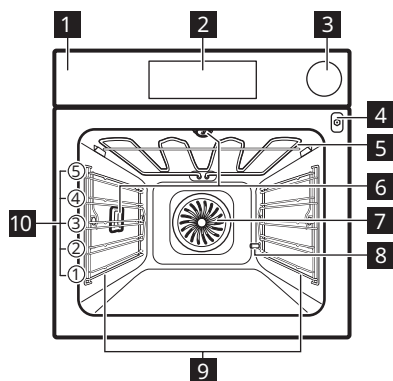

- 1** Pannello dei comandi
- 2** Display
- 3** Vaschetta dell'acqua
- 4** Presa per la termosonda
- 5** Resistenza
- 6** Lampadina
- 7** Ventola
- 8** Uscita tubo di decalcificazione
- 9** Supporto ripiano, rimovibile
- 10** Posizioni ripiano

Pannello dei comandi

Panoramica del pannello di controllo

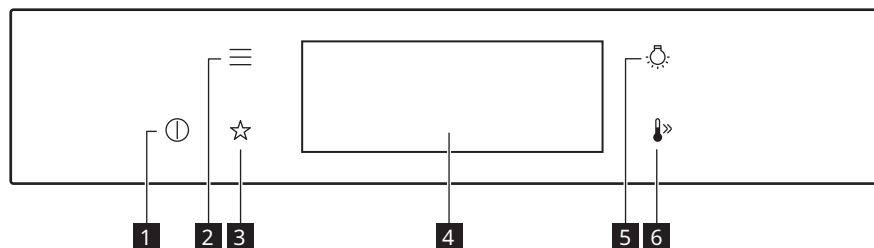

1	ON / OFF	Tenere premuto per accendere e spegnere l'apparecchiatura.
2	Menu	Elenca le funzioni dell'apparecchiatura.
3	Preferiti	Elenca le impostazioni preferite.
4	Display	Mostra le impostazioni correnti dell'apparecchiatura.

5	Interruttore lampadina	Per accendere e spegnere la lampadina.
6	Riscaldamento rapido	Per accendere e spegnere il forno: Riscaldamento rapido.

Spie display

Display con le funzioni chiave.

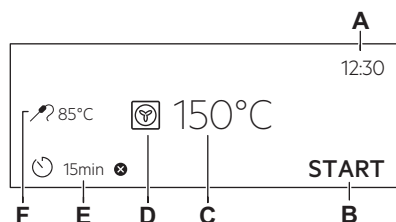

- A. Imposta ora
- B. START/STOP
- C. Temperatura
- D. Funzioni cottura
- E. Timer
- F. Termosonda (solo modelli selezionati)

Indicatori di base - per spostarsi sul display.

	Per confermare la selezione / l'impostazione.
	Per tornare indietro di un livello nel menu.
	Per annullare l'ultima azione.
	Per attivare o disattivare le opzioni.

Suono allarme indicatori funzione - al termine del tempo di cottura impostato, viene emesso un segnale acustico.

	La funzione è attiva.
	La funzione è attiva. La cottura si arresta automaticamente.
	Il suono allarme è disattivato.
	Per impostare la funzione: Partenza ritardata.
	Per annullare l'impostazione.

Utilizzo quotidiano

Funzioni cottura

STANDARD

	Cottura ventilata: Cottura omogenea, tenerezza, essiccazione
	Cottura convenzionale: Cottura tradizionale
	Cibi congelati: Patatine fritte, spicchi di patate, involtini primavera
	Funzione Pizza: Preparazione della pizza
	Resistenza inferiore: Preparazione di dolci da forno
	Grill: Tostatura, cottura al grill
	Doppio grill ventilato: Arrostire carne, rosolare





Cottura ventilata, Cottura convenzionale: quando si imposta la temperatura al di sotto di 80 °C, la lampada si spegne automaticamente dopo 30 sec.

FUNZIONI SPECIALI

	Marmellate/Conserve: Conservare le verdure
	Essiccazione: Essiccare frutta tagliata a fette, funghi
	Riscaldamento piatti: Preriscaldamento piatti
	Scongelo: Scongelo
	Gratinato: Gratin, doratura
	Cottura lenta: Preparazione di arrosti teneri
	Mantieni caldo: Mantenimento in caldo degli alimenti
	Cottura ventilata umida: Cottura al forno

VAPORE

	Easysteem: Cottura a vapore, stufati, gratinatura leggera, cottura al forno, arrosto
	Rigenera a vapore: Riscaldamento su un piatto

	Cottura Pane: Pane, panini
	Lievitazione pasta: Lievitazione impasto
	Cottura a vapore: Verdure, contorni, pesce
	Umidità alta: Creme, flan, terrine, pesce
	Umidità bassa: Carne, pollame, piatti da forno, sformati

Note su: Cottura ventilata umida

Questa funzione è stata utilizzata per la conformità alla classe energetica e ai requisiti di ecodesign (secondo la normativa EU 65/2014 e EU 66/2014). Test conformemente a:

IEC/EN 60350-1





La porta del forno dovrebbe essere chiusa in fase di cottura, in modo che la funzione non venga interrotta. Ciò garantisce inoltre che il forno funzioni con la più elevata efficienza energetica possibile.

Quando viene usata questa funzione, la lampada si spegne automaticamente dopo 30 secondi.

Questa funzione è progettata per il risparmio energetico durante la cottura. Quando si utilizza questa funzione, la temperatura all'interno della cavità potrebbe essere diversa rispetto alla temperatura impostata. La potenza riscaldante potrebbe essere ridotta.

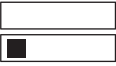
Durezza dell'acqua

È possibile modificare il livello di durezza dell'acqua nel menu: Impostazioni / Configurazione / Durezza dell'acqua.

Livello di durezza dell'acqua	Carta di test
1 - morbida	
2 - moderatamente dura	
3 - dura	
4 - molto dura ¹⁾	

1) Quando la durezza dell'acqua del rubinetto è al livello 4, riempire la vaschetta con acqua in bottiglia non gasata.

Risoluzione dei problemi

In caso di problemi con l'apparecchiatura consultare il capitolo "Risoluzione dei problemi" nella versione completa del

Manuale d'uso disponibile su:
www.ikea.com.

Informazioni sul prodotto e scheda informativa del prodotto

Nome del fornitore	IKEA
Identificazione modello	MUTEBO 105.570.41
Indice di efficienza energetica	61.9
Classe di efficienza energetica	A++
Consumo energetico con carico standard, modalità tradizionale	1.09 kWh/ciclo
Consumo di energia con un carico standard, modalità a circolazione d'aria forzata	0.52 kWh/ciclo
Numero di cavità	1
Fonte di calore	Elettricità
Volume	70 l

Tipo di forno	Forno da incasso
Massa	35,5 kg
IEC/EN 60350-1- Apparecchiature elettriche per la cottura per uso domestico - Parte 1: Cucine, forni, forni a vapore e griglie - Metodi per la misura delle prestazioni.	

Struttura del menu

Menu

Voce menu		Applicazione
Cottura guidata		Elenca i programmi automatici.
Pulizia		Elenca i programmi di pulizia.
Preferiti		Elenca le impostazioni preferite.
Opzioni		Per impostare la configurazione dell'apparecchiatura.
Impostazioni	Configurazione	Per impostare la configurazione dell'apparecchiatura.
	Assistenza tecnica	Mostra la versione del software e la configurazione.

Sottomenu per: Pulizia

Sottomenu	Applicazione
Asciugatura	Procedura per asciugare la cavità dalla condensa residua dopo l'uso delle funzioni vapore.
Svuotamento serbatoio	Procedura per la rimozione dell'acqua residua dalla relativa vaschetta dopo aver utilizzato le funzioni vapore.
Pulizia a vapore	Pulizia leggera.
Pulizia a vapore plus	Pulizia completa.
Decalcificazione	Pulizia del circuito di generazione del vapore dal calcare residuo.
Risciacquo	Procedura di risciacquo e pulizia del circuito di generazione vapore dopo un utilizzo frequente delle funzioni a vapore.

Sottomenu per: Opzioni

Sottomenu	Applicazione
Luce forno	Accensione e spegnimento della lampada.
Sicurezza bambini	Previene l'attivazione accidentale dell'apparecchiatura. Quando l'opzione è attiva, il testo Sicurezza bambini appare sul display all'accensione dell'apparecchiatura. Per abilitare l'uso dell'apparecchiatura, scegliere le lettere del codice in ordine alfabetico. L'accesso al timer, all'operazione da remoto e alla lampadina è disponibile con l'opzione attiva.
Riscaldamento rapido	Riduce il tempo di riscaldamento. È disponibile solo per alcune delle funzioni dell'apparecchiatura.
Promemoria Pulizia	Accende e spegne il promemoria.
Visualizza ora	Accende e spegne l'orologio.
Visualizzazione orario digitale	Cambia il formato dell'indicazione oraria visualizzata.

Sottomenu per: Configurazione

Sottomenu	Descrizione
Lingua	Imposta la lingua dell'apparecchiatura.
Luminosità	Imposta la luminosità del display.
Volume toni	Attiva e disattiva il tono dei tasti a sfioramento. Non è possibile disattivare i segnali acustici per: ①.
Volume acustico	Imposta il volume delle tonalità e dei segnali dei tasti.
Durezza dell'acqua	Imposta la durezza dell'acqua.
Imposta ora	Imposta l'ora e la data attuali.

Sottomenu per: Assistenza tecnica

Sottomenu	Descrizione
Modalità demo	Codice di attivazione/disattivazione: 2468
Versione software	Informazioni sulla versione software.
Ripristino impostazioni iniziali di fabbrica	Ripristina le impostazioni di fabbrica.

Produktbeskrivelse

Generell oversikt

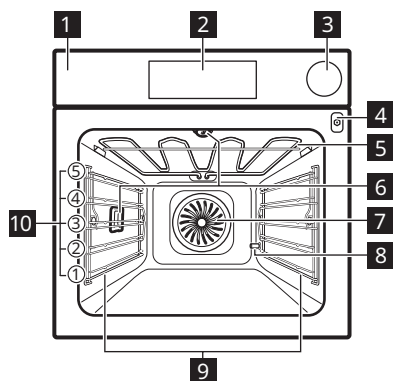

- 1** Betjeningspanel
- 2** Display
- 3** Vannskuff
- 4** Kontakt til steketermometer
- 5** Varmeelement
- 6** Lys
- 7** Vifte
- 8** Avkalking rørutløp
- 9** Uttakbare brettstiger
- 10** Hyllenivåer

Betjeningspanel

Oversikt over betjeningspanel

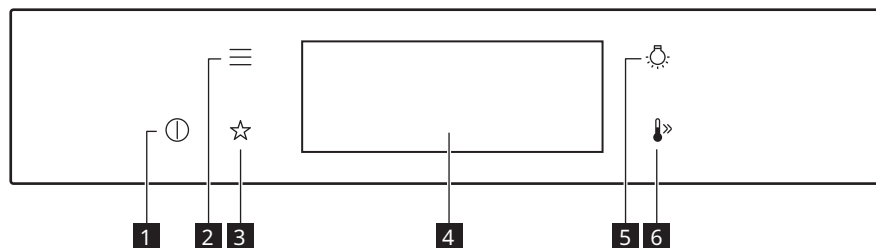

1	PÅ / AV	Trykk og hold for å slå produktet på og av.
2	Meny	Viser produktets funksjoner.
3	Favoritter	Viser favorittinnstillingene.
4	Display	Viser de gjeldende innstillingene for produktet.

5	Lysbryter	Slik slår du lampen av og på.
6	Hurtigoppvarming	Slik slår du funksjonen av og på: Hurtigoppvarming.

Displayindikatorer

Display med nøkkelfunksjoner.

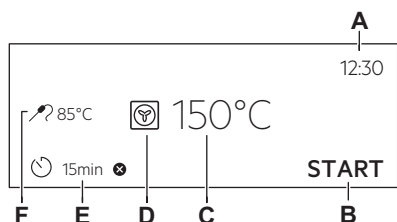

- A. Tid på dagen
- B. START/STOPP
- C. Temperatur
- D. Varmefunksjoner
- E. Timer
- F. Steketermometer (bare utvalgte modeller)

Grunnleggende indikatorer – for å navigere på displayet.

	For å bekrefte valget eller innstillingen.
	Gå ett nivå tilbake på menyen.
	Angre siste handling.
	For å slå alternativene på og av.

Lydsignal funksjonsindikatorer – når den valgte tilberedningstiden er slutt, hører du et lydsignal.

	Funksjonen er på.
	Funksjonen er på. Tilberedningen stopper automatisk.
	Lydsignalet er deaktivert.
	For å stille inn funksjonen: Utsatt start.
	Slik sletter du innstillingen.

Daglig bruk

Varmefunksjoner

STANDARD

	Ekte Varmluft: Tilberedning, mørhet, tørking
	Over- og undervarme: Tradisjonell steking
	Frossen mat: Pommes frites, potetbåter, vårruller
	Pizzafunksjon: Lage pizza
	Undervarme: Steking av kaker
	Grill: Brødristing, grilling
	Gratinerer med vifte: Steke kjøtt, bruning

Ekte Varmluft, Over- og undervarme: Når du stiller inn temperaturen under 80 °C, slås lampen automatisk av etter 30 sekunder.

SPESIALER

	Hermetisering: Hermetisering av grønnsaker
--	---

	Tøking: Tørke oppkuttet frukt, sopp
	Tallerkenoppvarming: Forvarme tallerker
	Tining: Tining
	Grateng: Gratenger, bruning
	Langtidssteiking: Tilberedning av mør stek
	Hold varm: Holde maten varm
	Baking med fukt: Steking

DAMP

	Easystem: Damping, stuing, lett sprøsteiking, baking, steking
	Damp-oppvarming: Oppvarming på en tallerken
	Brødbaking: Brød, rundstykker
	Deigheving: Heving av gjærdeig
	Full damp: Grønnsaker, mellomretter, fisk

	Fuktighet høy: Vaniljesaus, karamellpudding, gryter, fisk
	Fuktighet lav: Kjøtt, fjærkre, ovnsretter, retter form

Merknader om: Baking med fukt

Denne funksjonen blir brukt til å overholde energieffektivitetsklassen og økodesignkrav (i henhold til EU 65/2014 og EU 66/2014).
Tester i henhold til:

IEC/EN 60350-1

Stekeovnsdøren skal være lukket under tilberedning slik at funksjonen ikke forstyrres, og ovnen er i drift med høyest mulig energieffektivitet.





Når du bruker denne funksjonen, slås ovnslampen automatisk av etter 30 sekunder.

Denne funksjonen er laget med tanke på å spare energi når man lager mat. Når du

bruker denne funksjonen, kan temperaturen i ovnsrommet variere fra den angitte temperaturen. Varmeeffekten kan reduseres.

Vannhardhet

Du kan endre vannhardheten i menyen: Innstillinger / Oppsett / Vannhardhet.

Vannhardhetsnivå	Testpapir
1 - mykt	
2 - middels hardt	
3 - hardt	
4 - veldig hardt ¹⁾	

1) Fyll vannskuffen med flaskevann uten kullsyre når vannhardheten fra kranen er 4.

Feilsøking

Hvis du støter på et problem med produktet, sjekk kapittelet "Feilsøking" i den

fullstendige versjonen av bruksanvisningen som er tilgjengelig på: www.ikea.com.

Produktinformasjon og produktinformasjonsark

Leverandørens navn	IKEA
Modellidentifikasjon	MUTEBO 105.570.41
Energieffektivitetsindeks	61.9
Energieffektivitetsklasse	A++
Energiforbruk med standard matmengde, over- og undervarme	1.09 kWh/syklus
Energiforbruk med standardbelastning, viftemodus	0.52 kWh/syklus
Antall ovner	1
Varmekilde	Elektrisitet
Volum	70 l
Ovnstyper	Innebygd ovn
Masse	35.5 kg
IEC/EN 60350-1- Elektriske husholdningsapparater for matlaging - del 1: Sortiment, ovner, dampovner og griller - metoder for måling av ytelse.	

Menystruktur

Meny

Meny-element		Anvendelse
Assistert matlaging		Viser automatiske programmer.
Rengjøring		Viser rengjøringsprogrammer.
Favoritter		Viser favorittinnstillingene.
Alternativer		For å angi produktkonfigurasjonen.
Innstillinger	Oppsett	For å angi produktkonfigurasjonen.
	Service	Viser programvareversjon og konfigurasjon.

Undermeny for: Rengjøring

Undermeny	Anvendelse
Tørking	Prosedyre for tørking av gjenværende kondens i ovnsrommet etter bruk av dampfunksjonen.
Tømming av tank	Fremgangsmåte for fjerning av gjenværende vann fra vannskuffen etter bruk av dampfunksjonen.
Damprengjøring	Lett rengjøring.
Damprengjøring Plus	Grundig rengjøring.
Avkalking	Rengjøring av kalkrester fra kretsen for dampgenerering.
Skylling	Prosedyre for skylling og rengjøring av kretsen for dampgenerering etter hyppig bruk av dampfunksjonene.

Undermeny for: Alternativer

Undermeny	Anvendelse
Lys	Slår lyset av og på.
Barnesikring	Forhindrer utilsiktet aktivering av produktet. Når alternativet er på, vil teksten Barnesikring vises i displayet når du slår på produktet. Velg kodebokstavene i alfabetisk rekkefølge for å aktivere bruk av produktet. Tilgang til tidtaker, fjernstyring og lampe er tilgjengelig med alternativet på.
Hurtigoppvarming	Forkorter oppvarmingstiden. Den er kun tilgjengelig for enkelte av produktets funksjoner.
Rengjøringspåminnelse	Slår påminnelsen på og av.
Tidsindikasjon	Slår klokken på og av.
Digital klokkestil	Endrer formatet til den viste tidsangivelsen.

Undermeny for: Oppsett

Undermeny	Beskrivelse
Språk	Angir produktets språk.
Skjermlysstyrke	Angir skjermens lysstyrke.
Tastelyder	Slår tastelyden til sensorfeltene av og på. Det er ikke mulig å dempe lyden for: ①.
Summerlyd	Angir volumet på tastelyder og -signaler.
Vannhardhet	Stiller inn vannhardheten.
Tid på dagen	Stiller inn gjeldende tid og dato.

Undermeny for: Service

Undermeny	Beskrivelse
Demomodus	Aktiverings- / deaktiveringskode: 2468
Programvareversjon	Informasjon om programvareversjon.
Tilbakestill alle innstillinger	Tilbakestill til fabrikkinnstillingene.

Descrição do produto

Visão geral

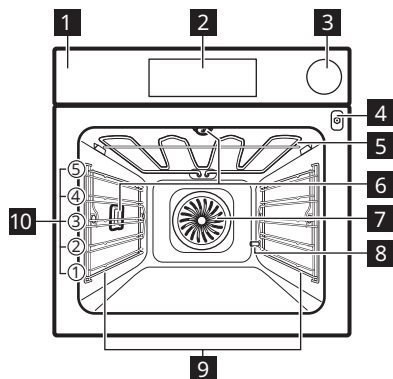

- 1** Painel de comandos
- 2** Visor
- 3** Gaveta da água
- 4** Tomada para a sonda térmica
- 5** Elemento de aquecimento
- 6** Lâmpada
- 7** Ventilador
- 8** Saída do tubo de descalcificação
- 9** Apoio para prateleira, amovível
- 10** Nível das prateleiras

Painel de comandos

Descrição geral do painel de comandos

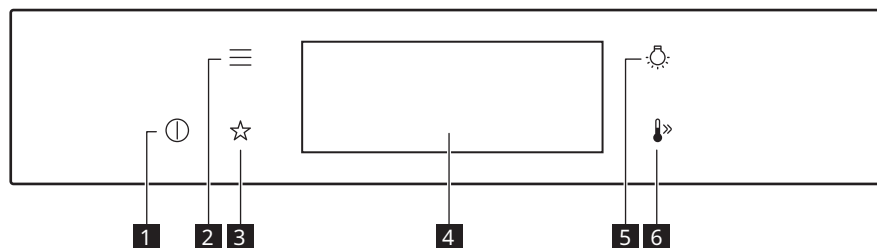

1	On / Off	Prima continuamente para ligar e desligar o aparelho.
2	Menu	Apresenta uma lista das funções do aparelho.
3	Favoritos	Lista as definições favoritas.
4	Visor	Apresenta as definições atuais do aparelho.

5	Interruptor da lâmpada	Para acender e apagar a lâmpada.
6	Aquecimento rápido	Para ativar e desativar a função: Aquecimento rápido.

Indicadores do visor

Visor com funções chave.

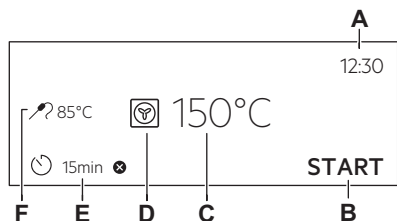

- A. Hora
- B. INICIAR/PARAR
- C. Temperatura
- D. Tipos de aquecimento
- E. Temporizador
- F. Sonda térmica (apenas modelos selecionados)

Indicadores básicos – para navegar no visor.

	Para confirmar a seleção/definições.
	Para voltar um nível no menu.
	Para desfazer a última ação.
	Para ativar e desativar as opções.

Alarme sonoro indicadores de função – quando as definições do tempo para cozinhar termina, é emitido um sinal sonoro.

	A função está ativada.
	A função está ativada. O cozinhar para automaticamente.
	O alarme sonoro está desativado.
	Para as definições da função: Início programado.
	Para cancelar as definições.

Utilização diária

Funções de aquecimento

NORMAL

	Ventilado + Resistência Circ: Assado uniforme, tenro, seco
	Calor superior/inferior: Cozedura tradicional
	Congelados: Batatas fritas, batatas em fatias, rolos de primavera
	Função Pizza: Fazer pizza
	Aquecimento inferior: Cozer bolos
	Grelhador: Tostar, grelhar
	Grelhador ventilado: Assar carne, alourar







Ventilado + Resistência Circ, Calor superior/inferior Quando selecionar uma temperatura inferior a 80 °C, a lâmpada desliga-se automaticamente após 30 seg.

ESPECIAIS

	Conservar: Conservar legumes
	Secar: Secar frutos fatiados, cogumelos
	Aquecer pratos: Placas de pré-aquecimento
	Descongela: Descongela
	Gratinado: Gratinar gratinados, alourar
	Aquecimento a baixa temp: Preparar carne assada tenra
	Função manter quente: Manter os alimentos quentes
	Ventilado com Resistência: Cozer no forno

VAPOR

	Easystem: Vapor, estufar, efeito estaladiço suave, cozer, assar
--	--

	Regenerar: Reaquecer num prato
	Pão: Pão, pastéis
	Massa de pão: Descongelar massa levedada
	Aquecimento a vapor: Legumes, guarnições, peixe
	Humidade elevada: Cremes, flans, terrinas, peixe
	Humidade pouca: Carne, aves, pratos de forno, caçarolas

Notas sobre: Ventilado com Resistência

Esta função foi utilizada para cumprir com os requisitos de classe eficiente energética e design ecológico (de acordo com as normas EU 65/2014 e EU 66/2014). Testes de acordo com:

IEC/EN 60350-1





A porta do forno deve estar fechada durante a cozedura para que a função não seja interrompida e o forno funcione com a mais alta eficiência energética possível.

Quando utiliza esta função, a lâmpada é automaticamente desativada após 30 seg.

Esta função foi concebida para poupar energia durante o cozinhado. Quando utilizar esta função, a temperatura na cavidade pode diferir a temperatura definida. A potência do aquecimento pode ser reduzida.

Dureza da água

Pode alterar o nível de dureza da água no menu: Definições / Configuração / Dureza da água.

Níveis de dureza da água	Papel de teste
1 - suave	
2 - moderadamente dura	
3 - dura	
4 - muito dura 1)	

1) Quando o nível de dureza da água for 4, encha a gaveta da água com água engarrafada.

Resolução de problemas

Se tiver um problema com o seu aparelho, consulte o capítulo "Resolução de

problemas" na versão completa do Manual do Utilizador disponível em: www.ikea.com.

Informação do produto e a Ficha de informação do produto

Nome do fornecedor	IKEA
Identificação do modelo	MUTEBO 105.570.41
Índice de Eficiência Energética	61.9
Classe de eficiência energética	A++
Consumo de energia com uma carga normal, modo convencional	1.09 kWh/ciclo
Consumo de energia com uma carga padrão, modo de ventilação forçada	0.52 kWh/ciclo
Número de cavidades	1
Fonte de calor	Eletricidade
Volume	70 l
Tipo de forno	Forno encastrado
Massa	35,5 kg

IEC/EN 60350-1 - Aparelhos de cozinha elétricos domésticos - Parte 1: Fogões, fornos, fornos a vapor e grelhadores - Métodos para medir o desempenho.

Estrutura do menu

Menu

Artigo do menu		Aplicação
Cozedura assistida		Lista os programas automáticos.
Limpeza		Lista os programas de limpeza.
Favoritos		Lista as definições favoritas.
Opções		Para definir a configuração do aparelho.
Definições	Configuração	Para definir a configuração do aparelho.
	Assistência Técnica	Apresenta a configuração e a versão do software.

Submenu para: Limpeza

Submenu	Aplicação
Secagem	Procedimento para secagem da cavidade relativamente à condensação remanescente após uma utilização das funções de vapor.
Esvaziam. do depósito	Procedimento para remover a água residual da gaveta da água após a utilização de funções de vapor.
Limpeza a vapor	Limpeza ligeira.
Limpeza a vapor Plus	Limpeza completa.
Descalcificação	Limpeza de resíduos de calcário do circuito de geração de vapor.
Enxaguamento	Procedimento para enxaguar e lavar o circuito de geração de vapor após utilização frequente das funções de vapor.

Submenu para: Opções

Submenu	Aplicação
Luz	Acende e apaga a lâmpada.
Bloqueio para crianças	Impede a ativação acidental do aparelho. Quando a opção está ativa, o texto Bloqueio para crianças é apresentado no visor quando ligar o aparelho. Para ativar a utilização do aparelho, escolha as letras do código na ordem alfabética. Aceda ao temporizador, o funcionamento remoto e a lâmpada estão disponíveis com a opção ativada.
Aquecimento rápido	Diminui o tempo de aquecimento. Está disponível apenas para algumas das funções do aparelho.
Aviso de limpeza	Liga e desliga o aviso.
Indicação do tempo	Liga e desliga o relógio.
Estilo Relógio Digital	Altera o formato da indicação da hora apresentada.

Submenu para: Configuração

Submenu	Descrição
Idioma	Define o idioma do aparelho.
Brilho do visor	Define a intensidade do visor.

Submenu	Descrição
Sons "teclado"	Liga e desliga o som dos campos de toque. Não é possível silenciar o som para: ①.
Volume do alarme	Define o volume dos tons das teclas e sinais.
Dureza da água	Define a dureza da água.
Hora	Definir a hora e a data atuais.

Submenu para: Assistência Técnica

Submenu	Descrição
Modo Demo	Código de activação / desactivação: 2468
Versão do software	Informação sobre a versão do software.
Restaurar configurações	Restaura as definições de fábrica.

Descripción del producto

Resumen general

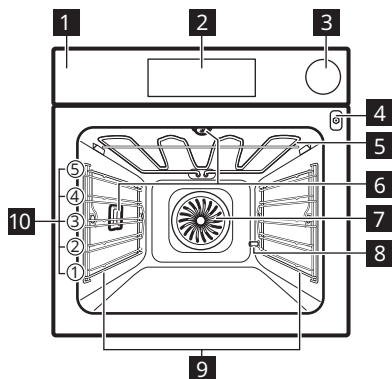

- 1** Panel de control
- 2** Pantalla
- 3** Compartimento de agua
- 4** Toma de la sonda térmica
- 5** Resistencia
- 6** Bombilla
- 7** Ventilador
- 8** Descalcificación de tubo de salida
- 9** Soporte de parrilla extraíble
- 10** Posiciones de las parrillas

Panel de control

Vista general del panel de control

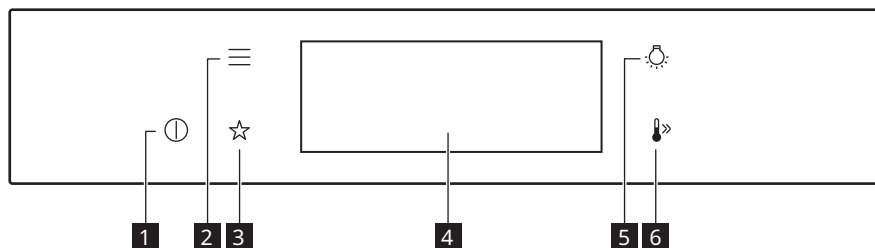

1	Encendido/ON / Apagado/OFF	Mantenga pulsado para encender y apagar el aparato.
2	Menú	Muestra las funciones del aparato.
3	Favoritos	Muestra los ajustes favoritos.
4	Pantalla	Muestra los ajustes actuales del electrodoméstico.

5	Interruptor de la lámpara	Enciende y apaga la luz.
6	Calentamiento rápido	Para activar y desactivar la función: Calentamiento rápido.

Indicadores de pantalla

Pantalla con funciones principales.

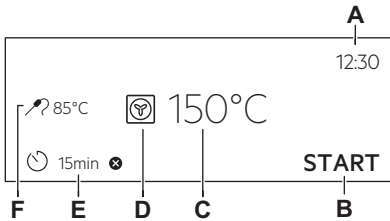

- A. Hora
- B. INICIO/PARAR
- C. Temperatura
- D. Funciones de cocción
- E. Temporizador
- F. Sonda térmica (solo en modelos seleccionados)

Indicadores básicos - para navegar por la pantalla.

	Para confirmar la selección o el ajuste.
	Para retroceder un nivel en el menú.
	Para deshacer la última acción.
	Para activar y desactivar las opciones.

Sonar la alarma indicadores de función - cuando finaliza el tiempo de cocción seleccionado, suena una señal acústica.

	La función está activada.
	La función está activada. La cocción se detiene automáticamente.
	El sonido de la alarma está apagado.
	Para ajustar la función: Inicio retardado.
	Para cancelar el ajuste.

Uso diario

Funciones de cocción

ESTÁNDAR

	Aire caliente: Horneado uniforme, ternura, secado
	Cocción convencional: Horneado tradicional
	Congelados: Patatas fritas, patatas, rollitos de primavera
	Función Pizza: Hornear pizza
	Calor inferior: Hornear pasteles
	Grill: Tostar, asar a la parrilla
	Grill turbo: Asar carne, dorar





Aire caliente, Cocción convencional: Cuando se ajusta la temperatura por debajo de 80 °C, la lámpara se apaga automáticamente después de 30 segundos.

PLATOS ESPECIALES

	Conservar: Conservar verduras
	Desecar alimentos: Secar rodajas de fruta, champiñones
	Calientaplatos: Pre calentamiento
	Descongelar: Descongelar
	Gratinar: Gratinar, dorados
	Cocción lenta: Preparación de asados tiernos
	Mantener Caliente: Mantener calientes los alimentos
	Horneado húmedo + ventilador: Horneado

VAPOR

	Easystem: Cocinar al vapor, estofar, dorar suavemente, hornear, asar
	Regenerar con vapor: Recalentamiento en un plato
	Horneado de pan: Pan, panecillos

	Leudar masas: Masa de levadura leudada
	Vapor solo: Verduras, guarniciones, pescado
	Humedad alta: Pudins, flanes, terrinas, pescado
	Humedad baja: Carne, aves, platos al horno, guisos

Notas sobre: Horneado húmedo + ventilador

Esta función se utilizaba para cumplir con los requisitos de eficiencia energética y diseño ecológico (según EU 65/2014 y EU 66/2014). Pruebas según:

IEC/EN 60350-1





La puerta del horno debe estar cerrada durante la cocción para que no se interrumpa la función y el horno funcione con la máxima eficiencia energética posible.

Cuando se utiliza esta función, la lámpara se apaga automáticamente después de 30 s.

Función diseñada para ahorrar energía durante la cocción. Cuando se utiliza esta función, la temperatura del horno puede diferir de la temperatura programada. La potencia calorífica puede reducirse.

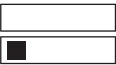
Dureza del agua

Puede cambiar el nivel de dureza del agua en el menú: Ajustes / Configuración / Dureza del agua.

Nivel de dureza del agua	Test reactivo
1 - suave	
2 - intermedia	
3 - dura	
4 - muy dura ¹⁾	

1) Cuando el nivel de dureza del agua sea 4, llene el compartimento de agua con agua embotellada.

Solución de problemas

Si tiene algún problema con el aparato, consulte el capítulo "Solución de problemas"

en la versión completa del manual del usuario disponible en: www.ikea.com.

Información del producto y hoja de información del producto

Nombre del proveedor	IKEA
Identificación del modelo	MUTEBO 105.570.41
Índice de eficiencia energética	61,9
Clase de eficiencia energética	A++
Consumo de energía con una carga estándar, modo convencional	1,09 kWh/ciclo
Consumo de energía con una carga estándar, modo de ventilador forzado	0,52 kWh/ciclo
Número de cavidades	1
Fuente de energía	Electricidad
Volumen	70 L
Tipo de horno	Horno empotrable
Masa	35,5 kg
IEC/EN 60350-1 - Aparatos electrodomésticos de cocción - Parte 1: Gamas, hornos, hornos de vapor y grills - Métodos de medida del rendimiento.	

Estructura del menú

Menú

Elemento del menú		Aplicación
Cocción asistida		Muestra los programas automáticos.
Limpieza		Muestra los programas de limpieza.
Favoritos		Muestra los ajustes favoritos.
Opciones		Para ajustar la configuración del aparato.
Ajustes	Configuración	Para ajustar la configuración del aparato.
	Asistencia	Muestra la configuración y la versión del software.

Submenú de: Limpieza

Submenú	Aplicación
Desecar	Procedimiento para secar la condensación restante en el interior después de usar las funciones de vapor.
Vaciado del depósito	Procedimiento para retirar el agua residual del compartimento de agua después de utilizar las funciones de vapor.
Limpieza vapor	Limpieza ligera.
Limpieza a vapor Plus	Limpieza a fondo.
Descalcificación	Limpieza de los restos de cal del circuito de generación de vapor.
Aclarado	Procedimiento para aclarar y limpiar el circuito de generación de vapor después de un uso frecuente de las funciones de vapor.

Submenú de: Opciones

Submenú	Aplicación
Luz	Enciende y apaga la luz.
Bloqueo de seguridad	Evita la activación accidental del aparato. Cuando la opción está activada, el texto Bloqueo de seguridad aparece en la pantalla al encender el aparato. Para activar el uso del aparato, seleccione las letras del código en orden alfabético. Acceda al temporizador, el funcionamiento remoto y la lámpara está disponible con la opción activada.
Calentamiento rápido	Reduce el tiempo de calentamiento. Solo está disponible para algunas de las funciones del aparato.
Aviso de limpieza	Activa y desactiva el recordatorio.
Indicación tiempo	Enciende y apaga el reloj.
Opción de hora digital	Cambia el formato de la indicación de tiempo mostrada.

Submenú de: Configuración

Submenú	Descripción
Idioma	Establece el idioma del aparato.
Brillo de la pantalla	Ajusta el brillo de la pantalla.
Tono de teclas	Activa y desactiva el tono de los campos táctiles. No es posible silenciar el tono de: ①.
Volumen del timbre	Ajusta el volumen de los tonos y señales de las teclas.
Dureza del agua	Ajusta la dureza del agua.
Hora	Ajusta la hora y la fecha actuales.

Submenú de: Asistencia

Submenú	Descripción
Modo demostración	Código de activación/desactivación: 2468
Versión del software	Información sobre versión de software.
Restaurar todos los ajustes	Restaura los ajustes de fábrica.

Produktbeskrivning

Allmän översikt

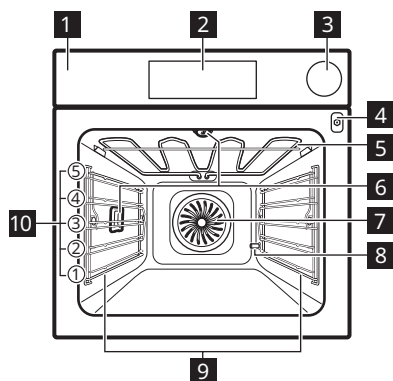

- 1** Kontrollpanel
- 2** Display
- 3** Vattenlåda
- 4** Uttag för matlagningstermometern
- 5** Värmeelement
- 6** Lampa
- 7** Fläkt
- 8** Avkalkning av rötutlopp
- 9** Ugnsstegar, borttagbara
- 10** Hyllplaceringar

Kontrollpanel

Översikt av kontrollpanelen

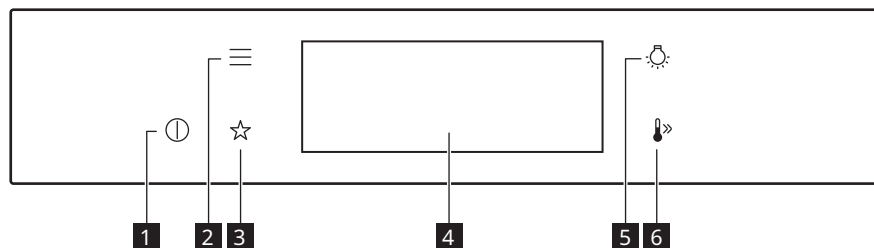

1	På / Av	Tryck och håll inne för att slå på och stänga av ugnen.
2	Meny	Visar ugnsfunktionerna.
3	Favoriter	Förteckning av favoritinställningar.
4	Display	Visar produktens aktuella inställningar.

5	Lampans strömbrytare	Tända och släcka lampan.
6	Snabbuppvärmning	Aktivera och inaktivera funktionen: Snabbuppvärmning.

Indikeringar på displayen

Display med inställda knappfunktioner.

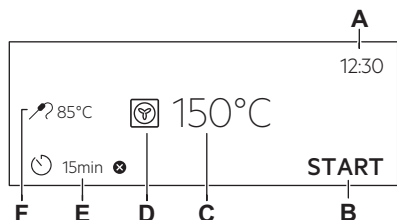

- A. Klockslag
- B. START/STOPP
- C. Temperatur
- D. Tillagningsfunktioner
- E. Timer
- F. Matlagningstermometer (endast vissa modeller)

Grundindikeringar - för att navigera på displayen.

	För att bekräfta val/inställning.
	Gå tillbaka en nivå i menyn så här.
	Ångra den senaste åtgärden så här.
	För att slå på och stänga av funktionerna.

Ljudalarm funktionsindikatorer - när den inställda tillagningstiden har gått avges en ljudsignal.

	Funktionen är på.
	Funktionen är på. Matlagningen avslutas automatiskt.
	Ljudalarm avstängt.
	För att ställa in funktionen: Fördröjd start.
	Avbryta inställningen.

Daglig användning

Värmefunktioner

STANDARD

	Varmluft: Jämn bakning, mörhet, torkning
	Över-/undervärme: Traditionell bakning
	Frost mat: Pommis frites, potatisklyftor, vårrullar
	Pizza/Paj: Pizza
	Undervärme: Mjuka kakor
	Grill: Rosta, grilla
	Varmluftsgrillning: Steka och bryna kött

Varmluft, Över-/undervärme När du ställer in temperaturen under 80 °C släcks lampan automatiskt efter 30 sekunder.



SPECIAL

	Konservering: Konservera grönsaker
--	---

	Torkning: Torka skivad frukt eller svamp
	Tallriksvärmning: Förvärma tallrikar
	Upptining: Upptining
	Gratinerig: Göra gratänger, bryna
	Långsam tillagning: Tillaga rostbiff
	Varmhållning: Varmhållning
	Bakning med fukt: Bakning

ÅNGA

	Easystem: Ånga, stuvning, lätt frasighet, baka, steka
	Uppvärmning med ånga: Uppvärmning på fat
	Brödbakning: Bröd, bullar
	Jäsning av deg: Degjäsning
	Full ånga: Grönsaker, smårätter, fisk

	Fuktighet, hög: Vaniljkräm, brylépudding, terriner, fisk
	Fuktighet, låg: Kött, fågel, ugnsrätter, grytor

Anvisningar om: Bakning med fukt

Denna funktion användes för att uppfylla kraven för energieffektivitet och ekodesigns /enligt EU 65/2014 och EU 66/2014). Tester enligt:

IEC/EN 60350-1

Ugnsluckan ska vara stängd under tillagningen så att funktionen inte avbryts och ugnen fungerar med högsta möjliga energieffektivitet.





Om du använder den här funktionen släcks lampan automatiskt efter 30 sekunder.

Denna funktion är för att spara energi under tillagningen. När du använder den här

funktionen kan temperaturen i ugnen skilja sig från inställd temperatur. Värmeeffekten kan minska.

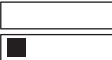
Vattenhårdhet

Du kan ändra nivån för vattnets hårdhetsgrad i menyn: Inställningar / Inställningar / Vattenhårdhet.

Vattnets hårdhetsnivå	Testpapper
1 - mjuk	
2 - medelhårt	
3 - hård	
4 - mycket svårt¹⁾	

1) När nivån på vattenhårdheten är 4, fyll vattenlådan med flaskvatten utan kolsyra.

Felsökning

Om du stöter på ett problem med din produkt, se kapitlet "Felsökning" i den fullständiga versionen av

användarhandboken som finns på: www.ikea.com.

Produktinformation och produktinformationsblad

Leverantörens namn	IKEA
Modellidentifiering	MUTEBO 105.570.41
Energieffektivitetsindex	61,9
Energieffektivitetsklass	A++
Energiförbrukning med en standardlast, konventionellt läge	1,09 kWh/cykel
Energiförbrukning med en standardbelastning, varmlufts läge	0,52 kWh/cykel
Antal kaviteter	1
Värmekälla	Elektricitet
Volym	70 l
Typ av ugn	Inbyggd ugn
Massa	35,5 kg
IEC/EN 60350-1- Elektriska hushållsapparater för matlagning - Del 1: Spisar, ugnar, ångugnar och grillar - metoder för att mäta prestanda.	

Menystruktur

Meny

Menyalternativ		Användning
Assisterad matlagning		Förteckning av automatiska program.
Rengöring		Förteckning av rengöringsprogram.
Favoriter		Förteckning av favoritinställningar.
Tillval		Används för att ställa in ugnskonfigurationen.
Inställningar	Inställningar	Används för att ställa in ugnskonfigurationen.
	Service	Visar programvarans version och konfiguration.

Undermeny för: Rengöring

Undermeny	Program
Torkning	Procedur för att torka ugnsutrymmet från kvarvarande kondens efter användning av ångfunktionerna.
Tömning av tanken	Procedur för att avlägsna restvatten från vattenlådan efter användning av ångfunktionen.
Ångrengöring	Lätt rengöring.
Ångrengöring Plus	Grundlig rengöring.
Avkalkning	Rengöring av kalkavlagringar på ångkretsen.
Sköljning	Metod för att skölja och rengöra ångkretsen när ångfunktionerna använts ofta.

Undermeny för: Tillval

Undermeny	Typ av inställning
Belysning	Tänder och släcker lampan.
Barnlås	Förhindrar oavsiktlig påslagning av ugnen. När alternativet är aktiverat visas texten Barnlås visas på displayen när du slår på produkten. Aktivera ugnen genom att sätta kodbokstäverna i alfabetisk ordning. Åtkomsten till timern, fjärrstyrningen och belysningen är tillgänglig när valet är aktiverat.
Snabbuppvärmning	Förkortar uppvärmningstiden. Det är endast tillgängligt för vissa ugnsfunktioner.
Påminnelse om rengöring	Slår på och stänger av påminnelser.
Visa klocka i standby	Slår på och stänger av tiden.
Klocka i digital stil	Ändrar formatet för tidsvisning.

Undermeny för: Inställningar

Undermeny	Beskrivning
Språk	Ställer in ugnens språk.
Ljusstyrka i display	Ställer in ljusstyrkan på displayen.
Knappljud	Slår på och stänger av ljudsignal för pekkontrollerna. Det går inte att stänga av ljudsignalen för: ①.
Ljudvolym knappar	Ställer in volymen på knappljud och signaler.
Vattenhårdhet	Ställer in vattnets hårdhetsgrad.
Klockslag	Ställer in aktuell tid och datum.

Undermeny för: Service

Undermeny	Beskrivning
Demoläge	Aktiverings-/avaktiveringskod: 2468
Programversion	Information om programversion.
Återställ alla inställningar	Återställer till fabriksinställningar.



867380093-B-372024

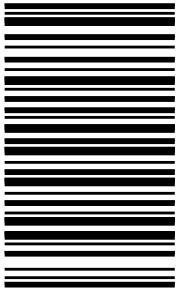

© Inter IKEA Systems B.V. 2024

21552

AA-2350580-2